

Bradford White **PDX Series**

Powered Direct Vent Gas Water Heaters



SERVICE **MANUAL**

**Troubleshooting Guide
and Instructions for Service**
(To be performed **ONLY** by qualified service providers)

**For Bradford White
PDX Series Models:**

PDX250T6*F(BN,CX)
PDX265T6*F(BN,CX)
PDX275T6*F(BN,CX)

PDX50S60F(B,C)*(N,X)
PDX65S65F(B,C)*(N,X)
PDX75S70F(B,C)*(N,X)

(*) Denotes Warranty Years

Bradford White **PDX Series** Powered Direct Vent Gas Water Heaters

Table of Contents

	<u>Page</u>	<u>TTW Service Procedure</u>
Introduction	4	---
How to use this manual	5	---
Tool required for service	5	---
Specifications	6	---
Control Timings	8	---
Sequence of Operation	9	---
Troubleshooting	12	---
Burner Inspection, Cleaning and Replacement	14	I
Pilot Testing, Cleaning and Replacement	16	II
Pressure Switch Testing and Replacement	17	III
Blower Testing and Replacement	21	IV
Blower Temperature Switch Testing and Replacement	23	V
Gas Control & Thermal well Testing & Replacement	25	VI
Flammable Vapor Sensor Testing & Replacement	29	VII
Safety Circuit Voltage Trace	30	VIII
115VAC Circuit Trace	31	IX
Dip Tube inspection and Replacement	32	X
Anode Inspection and Replacement	33	XI
Flue Baffle Inspection and Replacement	34	XII
Inner Door Removal, Inspection & Replacement	35	XIII
Glossary of Terms	38	---
Parts List	39	---

PDX Series

WARNING: If the information in these instructions is not followed exactly, a fire or explosion may result causing property damage, personal injury, or death.

FOR YOUR SAFETY

Do not store or use gasoline or other flammable, combustible, or corrosive vapors and liquids in the vicinity of this or any other appliance.

WHAT TO DO IF YOU SMELL GAS

Do not try to light any appliance.

- Do not touch any electrical switch; do not use any phone in your building.
- Immediately call your gas supplier from a neighbor's phone. Follow the gas supplier's instructions.
- If you cannot reach your gas supplier, call the fire department.

Installation and service must be performed by a qualified installer, service agency or the gas supplier.

CAUTION
Incorrect operation of this appliance may create a hazard to life and property and will nullify the warranty.

DANGER
Do not store or use gasoline or other flammable, combustible, or corrosive vapors and liquids in the vicinity of this or any other appliance.

IMPORTANT
Before proceeding, please inspect the water heater and its components for possible damage. DO NOT install any water heater with damaged components. If damage is evident then please contact the supplier where the water heater was purchased or the manufacturer listed on the rating plate for replacement parts.

WARNING
Water heaters are heat producing appliances. To avoid damage or injury, do not store materials against the water heater or vent-air intake system. Use proper care to avoid unnecessary contact (especially by children) with the water heater and vent-air intake components. **UNDER NO CIRCUMSTANCES MUST FLAMMABLE MATERIALS, SUCH AS GASOLINE OR PAINT THINNER BE USED OR STORED IN THE VICINITY OF THIS WATER HEATER, VENT-AIR INTAKE SYSTEM OR IN ANY LOCATION FROM WHICH FUMES COULD REACH THE WATER HEATER OR VENT-AIR INTAKE SYSTEM.**

CAUTION
If sweat fittings are to be used **DO NOT** apply heat to the nipples on top of the water heater. Sweat the tubing to the adapter before fitting the adapter to the water connections. It is imperative that heat is not applied to the nipples containing a plastic liner.

WARNING
Hydrogen gas can be produced in an operating water heater that has not had water drawn from the tank for a long period of time (generally two weeks or more). Hydrogen gas is extremely flammable. To prevent the possibility of injury under these conditions, we recommend the hot water faucet to be open for several minutes at the kitchen sink before you use any electrical appliance which is connected to the hot water system. If hydrogen is present, there will be an unusual sound such as air escaping through the pipes as hot water begins to flow. Do not smoke or have open flame near the faucet at the time it is open.

WARNING
DO NOT ATTEMPT TO LIGHT ANY GAS APPLIANCE IF YOU ARE NOT CERTAIN OF THE FOLLOWING:

- Liquefied petroleum gases/propane gas and natural gas have an odorant added by the gas supplier that aids in the detection of the gas.
- Most people recognize this odor as a "sulfur" or "rotten egg" smell.
- Other conditions, such as "odorant fade" can cause the odorant to diminish in intensity, or "fade", and not be as readily detectable.
- If you have a diminished sense of smell, or are in any way unsure of the presence of gas, immediately contact your gas supplier from a neighbor's telephone.

Gas detectors are available. Contact your gas supplier, or plumbing professional, for more information.

WARNING
FAILURE TO INSTALL AND MAINTAIN A NEW, LISTED 3/4" X 3/4" TEMPERATURE AND PRESSURE RELIEF VALVE WILL RELEASE THE MANUFACTURER FROM ANY CLAIM THAT MIGHT RESULT FROM EXCESSIVE TEMPERATURE AND PRESSURES.

CAUTION
Turn off or disconnect the electrical power supply to the water heater before servicing. Label all wires prior to disconnection when servicing controls. Wiring errors can cause improper and dangerous operation. Verify proper operation after servicing.

PDX Series

Introduction

The new Bradford White PDX2 and PDX water heaters are designed to provide reliable performance with enhanced standard features. New design features include reliable spark to pilot ignition system, enhanced diagnostics, simplified servicing, significantly quieter operation, additional vent lengths and certified FVIR technology.

Spark to Pilot Ignition System - employing the spark to pilot ignition system promotes reliable and consistent pilot and main burner ignitions to provide hot water on demand.

Integrated Immersion Thermostat/Gas Control Valve with LED - was developed for ease of troubleshooting by providing simple diagnostic codes to pinpoint an installation or component performance issue.

New Powerful Blower - will eliminate problems with difficult venting situations.

Quieter and Cooler Blower Operation - blower noise is significantly reduced for both interior and exterior environments. Cooler operation increases blower life by reducing bearing wear and noise.

Rugged Wiring Connections - receptacle type connections promote error free wiring.

Increased Vent Lengths - increased venting performance is achieved while maintaining Energy Factor & FHSR performance.

The PDX2 and PDX water heaters use a combustion system where flue gases are combined with dilution air to reduce the flue gas temperature in the blower, combustion air and dilution air are drawn from outside the building. The diluted flue gases are evacuated to the exterior through low temperature vent materials. The gas control maintains water temperature, ignition sequence and regulates gas flow. A safety circuit consisting of a pressure switch and blower temperature switch verifies proper conditions exist for safe and reliable operation. If a situation outside of normal operating parameters exists, the gas control diagnostic LED will flash a code to positively identify an operational issue.

This service manual is designed to facilitate problem diagnosis and enhance service efficiency. To further promote quicker service times the new gas valve can be removed and replaced without draining the water heater. A special tool is required and will be provided with each gas valve kit shipped from our Service Parts department.

Please read the service manual completely before attempting service on this new series of power vent models.

How the Safety System Works

During normal operation, air for combustion is drawn into the water heater through the vent pipe from outside your building. The air travels into the closed combustion chamber. The air then mixes with in a normal manner with supplied gas and is efficiently combusted, producing very low NOx emissions.

In the unlikely event trace amounts of flammable vapors are present in the area surrounding the water heater, the sealed combustion system prevents the flammable vapors from reaching the ignition source. In addition the flammable vapors sensor will stop the water heater from operating if a significant amount of flammable vapors are present.

It is intended for this manual to be used by qualified service personal for the primary purpose of troubleshooting and repair of the Bradford White TTW Series water heaters. Understanding the sequence of operation section of this manual will contribute greatly to troubleshooting the water heater.

The Honeywell WW4460E Electronic Gas Control will display error codes in the event of abnormal operation. Error codes are listed in the troubleshooting chart beginning on page 12 of this service manual. The troubleshooting chart will also indicate the probable cause for the error code and direct the service professional to a service procedure to properly diagnose the abnormal operation.

In some difficult to diagnose conditions, it may be necessary to isolate the heater from the vent system to determine the problem.

Contact the Bradford White technical support group immediately if diagnosis can not be made using the methods described in this service manual.

Tools Required for Service

Manometer:	A liquid "U" tube type or a digital (magna-helic) type can be used. This device is used to measure gas and/or air pressure and vacuum.
Multi-Meter:	A digital type is strongly recommended. This device is used to measure electrical values. The meter you select must have the capability to measure volts AC, volts DC, Amps, micro-amps and ohms.
Electronic Probes:	In some cases, standard multi-meter probes will damage or simply not be effective to obtain certain voltage and ohm reading. It will be necessary to have special electronic "pin" type multi-meter probes. These probes are available at most electronic wholesale outlets.
Thermometer:	Used to measure water temperature. An accurate thermometer is recommended.
Water Pressure Gage:	Used to measure water supply pressure. Also used to determine tank pressure by adapting to the drain valve of the heater.
Gas Control Service Tool:	BWC part number 239-45991-00. A specialized tool designed to remove the gas control from gas control thermal well. Available from your Bradford White parts supplier.
Various Hand Tools:	Pipe wrench, channel locks, open end wrenches (3/8", 7/16", 1/2"), 12" crescent wrench, Allen wrench set, screw drivers (common & Phillips), 1/4" nut driver, pliers (common & needle nose), socket set, side cutters wire cutters, wire strippers, wire crimpers, torpedo level, small shop vac, step ladder, and flashlight, 5 gallon pail.

Power supply	Dedicated 115VAC, 60 Hz, 15A
Gas Supply Pipe	Minimum 1/2" NPT (schedule 40 black iron pipe recommended)
Approved Gas Type	Natural or Propane. Unit must match gas type supplied.
Gas Pressure	5.0" W.C. min. for Nat gas, 11.0" W.C. min. for L.P. gas, 14.0" W.C. maximum (Nat. & L.P.)
Venting System	Power vent through the wall or vertical through the roof
Approved Vent Materials	PVC, CPVC or ABS
Minimum Clearance for Servicing	18" from top, 24" from front, 4" sides and rear.
Water Supply Pressure	150 PSI maximum allowable working pressure. Check local codes for supply pressure
Thermal well TCO Limit	Residential 188°F (87°C), Commercial 199°F (93°C)
Residential Temperature Set Point Range	60°F (16°C) to 160°F (71°C) (Approximate temperatures)
Commercial Temperature Set Point Range	80°F (27°C) to 180°F (82°C) (Approximate temperatures)
Blower Temperature Switch	Normally closed, opens @ 165°F (74°C), auto reset @ 130°F (54°C).
Pressure switch	Exhaust-Normally open, closes on vacuum increase @ -1.30. Intake-Normally closed, opens on vacuum increase @ -1.15.
Blower	115VAC, 60Hz, 3.1 amps.

Venting Specifications for:

Vent Tables

48 Gallon
65 Gallon
75 Gallon

This water heater is approved for installation with the following PVC, CPVC or ABS Schedule 40 venting material.

The maximum and minimum vent lengths listed on this label are for the exhaust portion of the vent. The intake portion of the vent must be equal to or less than the length of the exhaust.

3" Diameter (7.6 cm) PVC Vent Connector Lengths					
Terminating	# of Elbows	Maximum 48, 65 gal.		Maximum 75 gal.	
		Maximum Length ft (m)	Minimum Length ft (m)	Maximum Length ft (m)	Minimum Length ft (m)
Through the Wall	1	55 (16.8)	2 (.6)	45 (13.7)	2 (.6)
Through the Wall	2	50 (15.2)	2 (.6)	40 (12.2)	2 (.6)
Through the Wall	3	45 (13.7)	2 (.6)	35 (10.7)	2 (.6)
Through the Wall	4	40 (12.2)	2 (.6)	30 (9.1)	2 (.6)
Through the Roof	0	60 (18.3)	7 (2.1)	50 (15.2)	7 (2.1)
Through the Roof	1	55 (16.8)	7 (2.1)	45 (13.7)	7 (2.1)
Through the Roof	2	50 (15.2)	7 (2.1)	40 (12.2)	7 (2.1)
Through the Roof	3	45 (13.7)	7 (2.1)	35 (10.7)	7 (2.1)

4" Diameter (10.2 cm) PVC Vent Connector Lengths					
Terminating	# of Elbows	Maximum 48, 65 gal.		Maximum 75 gal.	
		Maximum Length ft (m)	Minimum Length ft (m)	Maximum Length ft (m)	Minimum Length ft (m)
Through the Wall	1	95 (29.0)	10 (3.1)	85 (25.9)	10 (3.1)
Through the Wall	2	90 (27.4)	10 (3.1)	80 (24.4)	10 (3.1)
Through the Wall	3	85 (25.9)	10 (3.1)	75 (22.9)	10 (3.1)
Through the Wall	4	80 (24.4)	10 (3.1)	70 (21.3)	10 (3.1)
Through the Wall	5	75 (22.9)	12 (3.6)	65 (19.8)	12 (3.6)
Through the Roof	0	100 (30.5)	15 (4.6)	90 (27.4)	15 (4.6)
Through the Roof	1	95 (29.0)	15 (4.6)	85 (25.9)	15 (4.6)
Through the Roof	2	90 (27.4)	15 (4.6)	80 (24.4)	15 (4.6)
Through the Roof	3	85 (25.9)	15 (4.6)	75 (22.9)	15 (4.6)
Through the Roof	4	80 (24.4)	15 (4.6)	70 (21.3)	15 (4.6)

Control Timings

<u>Ignition State</u>	<u>Timing</u>
Pre-purge	2 Seconds
Trial for Ignition	90 Seconds
Flame Stabilization Period	3 Seconds
Inter-purge	15 Seconds
Flame Failure Response Time	1.5 Seconds (2 second. Maximum; 1 second minimum.)
Post-purge	15 Seconds
PS Fault Delay (failed open/close)	Retry after 2 Minutes
Soft Lockout	Retry after 5 Minutes
TCO Limit Lockout	Indefinite (cycle power to restart)
Verify Resistive Delay	Retry after 2 Minutes (repeats 5 times)
Simulated Resistive Load Lockout	Indefinite (cycle power to restart)
Hardware Error Lockout	Indefinite (self clears if fault clears for at least 15 seconds)

Wiring Diagram

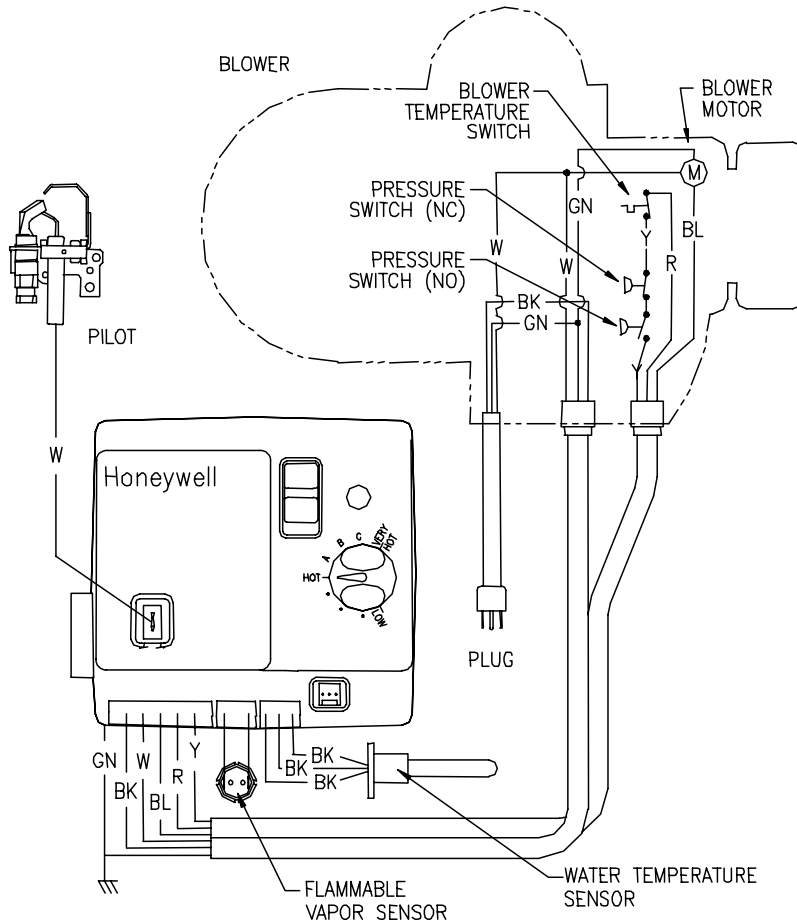

Power up Sequence

- 1 Start Up.
Upon power up, the control runs a safe-start check with a typical start-up delay of 1-5 seconds.
- 2 Flammable Vapor Check.
To assure no outputs are energized if the “Flammable Vapor Sensor” is out of range, the control will test the the “Flammable Vapor Sensor” for proper operating range. If the “Flammable Vapor Sensor” is within range the control resumes normal operation with no perceptible delay. If the “Flammable Vapor Sensor” is out of range, the control LED immediately flashes *7 times* with 3 second pause.

Normal Heating Sequence

- 1 Thermostat calls for heat.
Prior to energizing blower, gas control checks safety circuit to insure the circuit is open. Normal switch positions in the safety circuit are as follows:
 - a) Exhaust pressure switch normally open.
 - b) Blower temperature switch normally closed.
 - c) Inlet pressure switch normally closed.If the safety circuit is closed, the control waits 4 seconds, gas control LED flashes *2 times* with 3 second pause. Gas control waits 2 minutes then, blower runs for 30 seconds. This cycle repeats until safety circuit opens.
- 2 Blower energizes.
- 3 Blower pre-purge period (2 seconds)
- 4 Exhaust pressure switch proves blower/vent system operation.
 - a) If the pressure switch does not close within 30 seconds, the control LED Flashes *3 times* with 3 second pause. The blower runs for 30 seconds every 2 minutes trying to get the pressure switch or blower temperature switch to close. This cycle repeats as long as there is a call for heat.
 - b) The normally closed inlet pressure switch allows the system to work as long as the inlet air is not blocked.
- 5 Trial for pilot ignition (90 seconds).
 - a) The gas control lights the pilot by activating spark igniter and gas flow to pilot burner.
 - b) If flame is not sensed within 90 seconds, igniter and gas flow are deactivated, blower will post purge and control LED flashes *6 times* with 3 second pause.
- 6 Main burner Ignition
After pilot flame is sensed, gas control activates main valve for main burner ignition. The gas control will ignore flame and pressure switch signals for 3 seconds allowing for main burner to stabilize.

Normal Heating Sequence (cont.)

Steady state operation.

7

During Steady State Operation the Control Monitors:

Thermostat temperature sensor- When set point temperature is satisfied, gas valve is shut down and blower will post purge for 15 seconds. Control LED flashes a short flash once every 4 seconds (*idle*) status code.

Pressure switch / Blower temperature switch- If either switch opens, pilot valve and main valve is shut down. The blower continues to run for 30 seconds attempting to close the circuit. The control LED Flashes 3 *times* with 3 second pause.

Flame Sense- If flame is lost, pilot & main valve are shut down, blower runs for 15 seconds. Control attempts to re-light pilot 4 times. If unsuccessful, Blower is shut down and control proceeds to 5 minute lockout. Control re-attempts to light pilot starting at normal heating sequence #2.

8

Thermostat satisfies.

9

Burner off.

10

Blower post purge (15 seconds).

Abnormal Operation

1. Simulated Resistive Device Fault:

- a) **If the Flammable Vapor Sensor resistance is greater than 70,000 Ohms** - the gas control immediately turns off all outputs. Control waits and monitors resistance for 30 seconds. If the resistance is greater than 70,000 ohms after 30 seconds, the gas control proceeds to verify resistive delay for 2 minutes and flashes 7 *times* with a three second pause. This process is repeated 5 times until the control either returns to normal operation or proceeds to a lockout mode flashing 7 *times* with a 3 second pause.
- b) **If the Flammable Vapor Sensor resistance is below 3000 ohms** - The gas control immediately turns off all outputs and proceeds to flash 8 *times then once* with three second pause. The error self clears if the resistance returns to normal range for at least 15 seconds.

2. Temperature Sensor Fault:

- a) **Temperature sensor detected open circuit** - The gas control Immediately turns off all outputs and proceeds to flash 8 *times then three times* with three second pause. The error self clears if the fault clears for at least 15 seconds.
- b) **Temperature sensors not reading the same temperature within ± 5.5 °F** - The gas control Immediately turns off all outputs and proceeds to flash 8 *times then three times* with three second pause. The error self clears if the fault clears for at least 15 seconds.
- c) **Water temperature in excess of TCO (Temperature Cut Off) limit** - The gas control immediately turns off pilot & main valve and proceeds to flash 4 *times* with 3 second pause. Blower continues to run until gas control is reset. Power needs to be cycled to remove gas control from TCO lockout.

Abnormal Operation (cont.)

3. Pressure Switch/Blower Temperature Fault:

- a) **Pressure switch closed at start of call for heat** - The control waits four seconds then, proceeds to flash *2 times* with 3 second pause. The control waits 2 minutes and then turns on blower for 30 seconds. The blower turns off after 30 seconds and the control waits for pressure switch to open. Any time the Pressure switch opens, the blower turns on (or stays on) and the control proceeds to waiting for pressure switch to close.
- b) **Pressure switch or blower temperature switch failed open** - The control runs the blower for 30 seconds waiting for the pressure switch and/or blower temperature switch to close. If either switch does not close in 30 seconds, the blower turns off and the control flashes *3 times* with 3 second pause. The control waits two minutes before turning on the blower for another 30 seconds to see the circuit close. This cycle repeats as long as there is a call for heat or until the circuit closes.
- c) **Pressure switch or blower temperature switch opens during burner operation** - The control turns off the pilot and main valve, runs blower for 15 seconds (inter-purge) waiting for pressure switch and/or blower temperature switch to close. If either switch fails to close, the control proceeds as described in 3b above. If the circuit closes again by the end of the inter-purge, the recycle counter is incremented, if the recycle count has not reached its limit (4), another trial for ignition begins. If the recycle count has been reached, the control turns off the blower and flashes *6 times then 2 times* with 3 second pause. The control waits 5 minutes before repeating ignition sequence.
- d) **Normally closed intake pressure switch opens at start of call for heat**-the control runs the blower for 30 seconds waiting for the pressure switch to close. If the switch does not close in 30 seconds, the blower turns off and the control flashes 3 times with a 3 second pause. The control waits two minutes before turning on the blower for another 30 seconds to see the circuit close. This cycle repeats as long as there is a call for heat or until the circuit closes.

4. Trial For Ignition Fault:

- a) **Pressure switch opens during trial** - The control turns off igniter and pilot valve. The gas control proceeds as described in 3b above. If the pressure switch closes within 30 seconds the gas control will continue with trial for ignition starting at blower pre-purge.
- b) **Flame Not Sensed** - The control energizes the spark igniter attempting to light the pilot and prove flame. If flame is not sensed within 90 seconds, the igniter turns off, the pilot valve is closed and the gas control runs the blower through post purge and flashes *6 times then once* with 3 second pause. The control waits 5 minutes before repeating the ignition sequence.

5. Flame Sensing Fault:

- a) **Flame lost during run** - The control turns off pilot and main valves, runs blower for 15 seconds (inter purge). The control increments the recycle count, if the recycle count has not reached its limit (4), another trial for ignition begins. If the recycle count has been reached, the control turns off the blower and flashes *6 times then 3 times* with 3 second pause. The control waits 5 minutes before repeating the ignition sequence.
- b) **Flame sensed out of sequence** - the control only looks for pilot flame when the blower is running. If flame is present when the pilot valve is not open, the control proceeds to wait for flame loss and flashes *5 times* with 3 second pause. This continues until flame is lost, once the flame signal is lost, the control flashes *6 times then 4 times* with 3 second pause. The control waits 5 minutes before repeating the ignition sequence.

Observe green LED indicator on Electronic gas control. Error flash codes are displayed with a three second pause before repeating. Check and repair the system as noted in the troubleshooting table below.

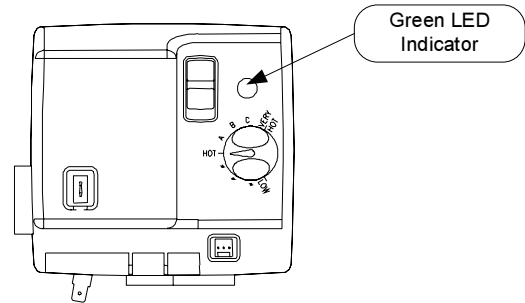

<u>LED Status</u>	<u>Control Status</u>	<u>Probable Cause</u>	<u>Service Procedure</u>
None, control LED not on or flashing	No electrical power	Control power switch in "OFF" position. Supply voltage interrupted.	Turn power on
Short flash, once every four seconds	Stand-by mode, Waiting for call for heat (no fault).	Temperature demand is satisfied	Normal operation. Adjust thermostat to temp level
"Heartbeat", alternates bright/dim	Thermostat calling for heat (no fault).	Tank temperature below set point of thermostat.	Normal operation. Adjust thermostat to temp level
Short flash once per second	Weak pilot signal on last call for heat.	<ol style="list-style-type: none"> 1. Unstable pilot. 2. Pilot tube block or restricted. 3. Oxidation build up on pilot electrode. 4. Wire damage to pilot assembly or bad connection at gas valve. 	<ol style="list-style-type: none"> 1. Page 14 2-4. Page 16
Two flash, three second pause	Pressure switch not working-closed position.	<ol style="list-style-type: none"> 1. Pressure switch tubing kinked or blocked. 2. Blocked pressure tap on switch or blower. 3. Faulty pressure switch. 	Page 17
Three flash, three second pause	Pressure switch or blower temp. switch not working-open position.	<ol style="list-style-type: none"> 1. Vent blockage or improper vent configuration. 2. Pressure switch tubing kinked or blocked. 3. Faulty pressure switch. 4. Blower not spinning up to speed. 5. Blower temp or exhaust temp too high 6. Faulty blower temperature switch. 7. Intake vent length exceeds exhaust vent length. 	<ol style="list-style-type: none"> 1. Check vent or vent tables. 2 & 3 Page 17 4. Page 21 5 & 6 Page 23
Four flash, three second pause	Excessive tank temperature. System must be reset.	<ol style="list-style-type: none"> 1. Thermal well sensor out of calibration. 2. Faulty gas control. 3. Plumbing leak 	<ol style="list-style-type: none"> 1. Page 25 2. Replace gas control, page 27
Five flash, three second pause	Undesired-false pilot flame present.	<ol style="list-style-type: none"> 1. Pilot valve stuck in open position. 	Replace gas control, page 27

<u>LED Status</u>	<u>Control Status</u>	<u>Probable Cause</u>	<u>Service Procedure</u>
Six-one flash, three second pause	Failed to light pilot. System auto resets.	<ol style="list-style-type: none"> 1. Unstable pilot. 2. Pilot tube blocked or restricted. 3. Oxidation build up on pilot electrode. 4. Wire damage to pilot assembly or bad connection at gas valve. 	<ol style="list-style-type: none"> 1. Page 14 2-4. Page 16
Six-two flash, three second pause	Pressure switch or blower temp switch opened during burner operation. System auto resets.	<ol style="list-style-type: none"> 1. Vent blockage or improper vent configuration. 2. Pressure switch tubing kinked or blocked. 3. Faulty pressure switch. 4. Vent termination being affected by wind 5. Blower not spinning up to speed. 6. Blower temp or exhaust temp too high 7. Faulty blower temperature switch. 	<ol style="list-style-type: none"> 1. Check vent or vent tables. 2 & 3 Page 17 4. Refer to venting section of installation manual 5. Page 21 6 & 7 Page 23
Six-three flash, three second pause	Pilot flame extinguished. System auto resets.	<ol style="list-style-type: none"> 1. Unstable pilot. 2. Pilot tube blocked or restricted. 3. Oxidation build up on pilot electrode. 4. Wire damage to pilot assembly or bad connection at gas valve. 5. Insufficient combustion air. 6. Gas pressure is out of specification. 	<ol style="list-style-type: none"> 1. Page 14 2-4. Page 16 5. Refer to installation manual
Six-four flash, three second pause	Undesired-false pilot flame sensed. System auto resets.	Pilot valve stuck in open position.	Replace gas control, page 27
Seven flash, three second pause	Flammable Vapor Sensor fault detected	<p style="text-align: center;">WARNING: EXPLOSION HAZARD</p> <ul style="list-style-type: none"> * Indicates gasoline vapors were detected at potentially explosive levels. * Verify no gasoline vapors are still present * Reset the control by cycling power to the appliance or by cycling the ON/OFF switch. * Replace the Flammable Vapors Sensor element if a gasoline spill event occurred. 	Page 29
Eight-one flash, three second pause	Flammable Vapor Sensor out of specification.	<ul style="list-style-type: none"> * Verify Flammable Vapor Sensor (FVS) resistance is not below 25 K Ohms. * Check wiring to FVS and insure it is not shorted. * Replace control if everything above checks out OK. 	Page 29
Eight-three flash, three second pause	Thermal well sensor damaged or unplugged	<ol style="list-style-type: none"> 1. Damage to thermal well wire. 2. Thermal well sensor resistance out of range. 	Page 25
	Gas valve electronics fault detected	<ol style="list-style-type: none"> 1. Control needs to be reset. 2. Control is wet or physically damaged. 	<ol style="list-style-type: none"> 1. Interrupt power supply 2. Replace gas control, page 27
Eight-four flash, three second pause	Gas valve fault detected.	<ol style="list-style-type: none"> 1. Control needs to be reset. 2. Control is wet or physically damaged. 	<ol style="list-style-type: none"> 1. Interrupt power supply 2. Replace gas control, page 27

Burner Inspection and Air Shutter Adjustment.

At periodic intervals (every 6 months) a visual inspection should be made of the pilot and main burner for proper operation and to assure no debris is accumulating.

Pilot flame should be stable, some causes for an unstable pilot flame are:

- a) Water heater vent is less than the allowable vent length.
- b) Gas pressure is out of specification.
- c) Pilot flame not fully engulfing spark/flame sensor.

Main burner should light smoothly from pilot and burn with a blue flame with a minimum of yellow tips.

Steel burner models self adjust air to gas ratio mixture and do not have an adjustable air shutter. Cast iron burner can have the gas and air mixture properly proportioned by adjusting the air shutter on the mixer face of the main burner (see cast iron burner adjustment below).

Main burner must be free from any debris accumulation that may effect burner operation (see burner cleaning procedure on page 14).

Cast Iron Burner Air Shutter Adjustment

▲ WARNING

Inner door and burner components may be HOT when performing this operation. Take necessary precaution to prevent personal injury.

- Step 1. With main burner in operation, remove outer jacket door remove inner door as described in this manual, see inner door removal, inspection and replacement section (page 35).
- Step 2. To adjust for proper burning, loosen the air shutter nut, rotate the air shutter to close the opening in the burner, then slowly rotate the air shutter open until flame becomes as blue as possible with a minimum of yellow tips. Tighten the air shutter nut.
- Too much air will cause the flame to lift off the burner ports and create noisy burner operation.
Too little air will result in soot formation.
- Step 3. Replace inner door as described in this manual, observe burner operation. Burner should operate as adjusted in step 2. If not, repeat air shutter adjustment compensating for proper burner operation with inner door closed.

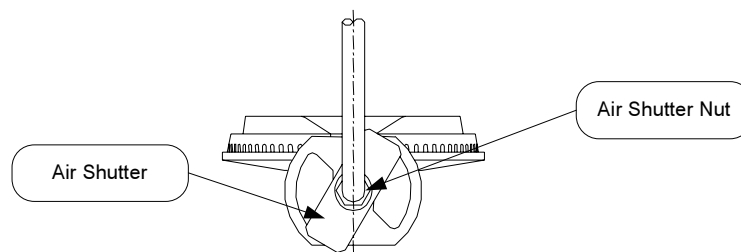

Burner Cleaning

- Step 1. Position gas control power switch to the "OFF" position and unplug heater from wall outlet.
- Step 2. Turn off gas supply to water heater.
- Step 3. Remove outer jacket door and inner door per service procedure XIII on page 35.
- Step 4. Disconnect pilot tube (7/16 wrench) and feedline (3/4 wrench) from gas control.
- Step 5. Disconnect igniter/flame sensor wire from gas control.
- Step 6. Remove burner assembly from combustion chamber.
- Step 7. Thoroughly inspect burner surface area and burner port area and remove any loose debris.
- Step 8. For cast iron burners, inspect for any debris build up inside burner casting.

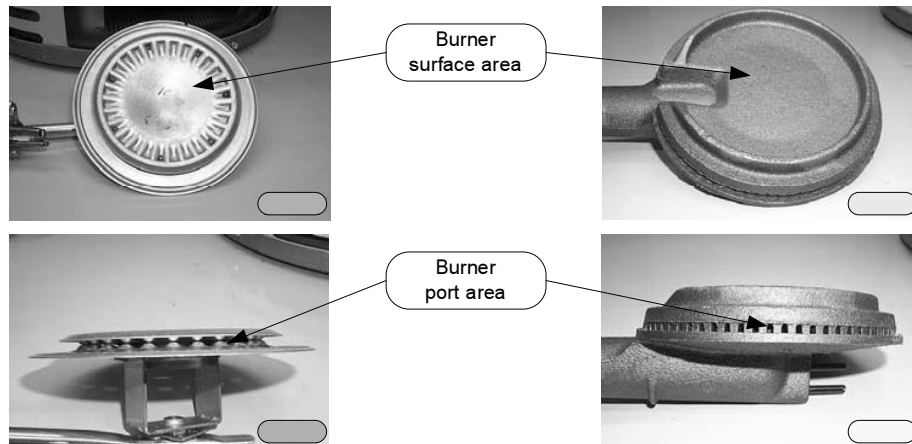
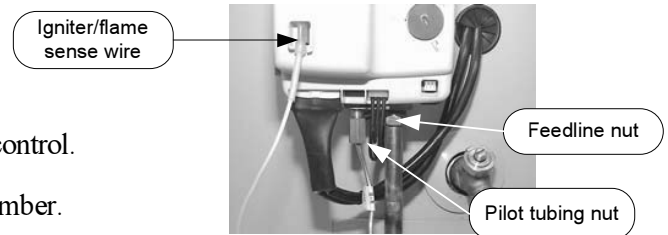

- Step 9. Unscrew burner from main burner orifice. On cast iron burners, loosen air shutter nut and unscrew feedline from burner.

- Step 10. Remove main burner orifice from feedline (1/2" wrench on steel burners, 3/8" wrench on cast iron) inspect orifice, clean or replace if necessary.

- Step 11. Reassemble burner and reinstall into water heater. Restore gas supply and check for gas leaks.

- Step 12. To resume operation follow the instruction located on the lighting instruction label or the lighting instruction located in the installation and operating manual.

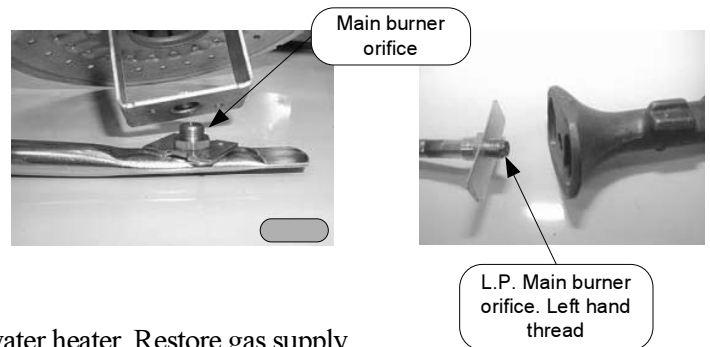

Pilot Inspection, Testing and Replacement

- Step 1. Position gas control power switch to the "OFF" position and unplug heater from wall outlet.
- Step 2. Turn off gas supply to water heater.
- Step 3. Remove outer jacket door and remove inner door per service procedure XIII on page 35.

Step 4. Disconnect pilot tube nut (7/16 wrench) and feedline nut (3/4 wrench) from gas control.

Step 5. Disconnect igniter/flame sense wire from gas control.

Step 6. Remove burner assembly from combustion chamber.

Step 7. Remove pilot assembly from feedline (1/4" nut driver).

Step 8. Visually inspect igniter/flame sense wire for damage. Replace pilot if damage is found.

Step 9. With a multi-meter set to the ohms setting, check continuity through igniter/flame sense wire. Replace pilot if no continuity.

Step 10. Visually inspect igniter/flame sense electrode for deterioration. Replace pilot as necessary. Electrode should not be in contact with pilot hood. If so, carefully adjust electrode to a gap distance of 3/32" (.09) from pilot hood.

Step 11. Visually inspect igniter/flame sense electrode for oxidation build up. Carefully clean any oxidation using very fine emery cloth.

Step 12. Visually inspect pilot tubing for kinks or cracks. If damage is found replace pilot.

Step 13. Inspect pilot tubing and pilot orifice for blockage:
a) Remove ferrule nut from bottom of pilot assembly (7/16" wrench).
b) Remove pilot tube and pilot orifice.
c) Inspect pilot tubing and pilot orifice for blockage. Clean or replace as necessary.

Step 14. Reassemble pilot and install to feedline. Reinstall burner assembly to water heater. Restore gas supply and check for gas leaks.

Step 15. To resume operation follow the instruction located on the lighting instruction label or the lighting instruction located in the installation and operating manual.

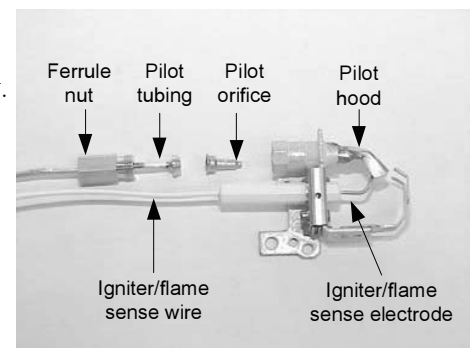
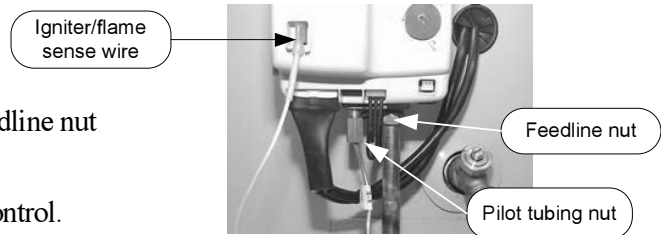

Exhaust Pressure Switch Testing

▲ WARNING
120 volt potential exposure. Use caution making voltage checks to avoid personal injury.

- Step 1. Position power switch on gas control to the "OFF" position.
- Step 2. Remove the three screws (Phillips screw driver) from control access cover on blower assembly and remove cover (see photo 1).
- Step 3. Remove tubing and wires from inlet pressure switch.
- Step 4. Carefully remove pressure switch from blower housing (see photo 2)

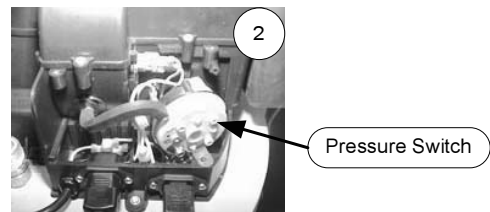
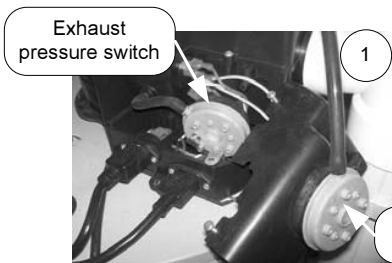

With steps 1,2,3 & 4 complete, disconnect wire leads from pressure switch.

Slide pressure switch in direction of arrow while tilting slightly away from blower housing.

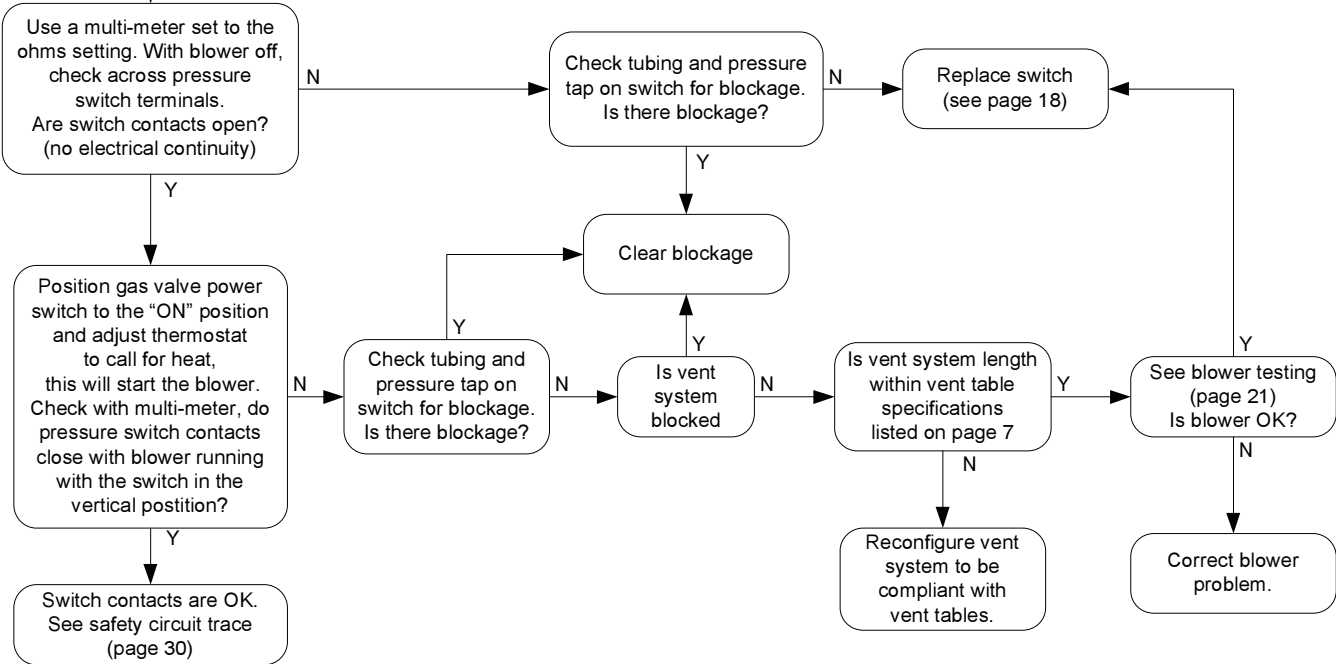

Exhaust Pressure Switch Replacement

⚠ WARNING
120 volt potential exposure. Use caution
to avoid personal injury.

- Step 1. Position gas control power switch to “OFF” position.
- Step 2. Remove the three screws (Phillips screw driver) from control access cover on blower assembly and remove cover (see photo 3).
- Step 3. Disconnect the tubing and wires from inlet pressure switch.

- Step 4. Carefully remove pressure switch from blower housing (see photo 4)

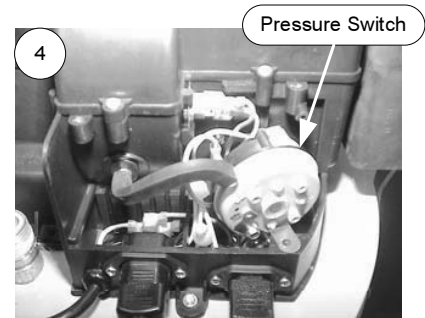
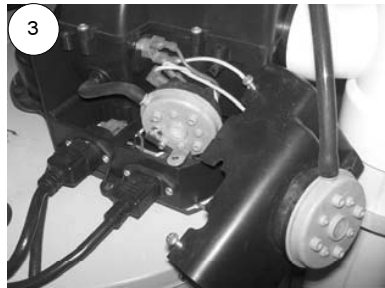

➔
Slide pressure switch in direction
of arrow while tilting slightly away
from blower housing.

- Step 5. Disconnect tubing from pressure switch. (see photo 5)

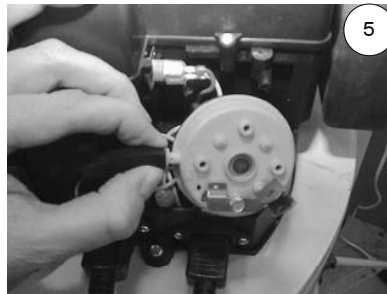

- Step 6. Disconnect yellow wires from pressure switch (see photo 6)

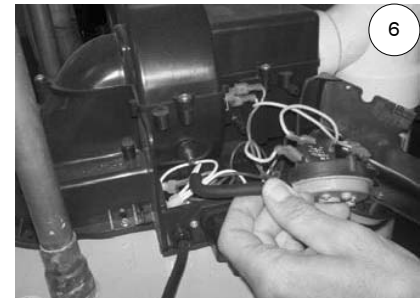

- Step 7. Reconnect wires from step 5 to new pressure switch.
- Step 8. Reconnect tubing to new pressure switch.
- Step 9. Carefully position pressure switch into blower housing.
- Step 10. Reconnect wires and tubing to inlet pressure switch.
- Step 11. Position gas control power switch to “ON” position and verify proper heater operation.
- Step 12. Replace control access cover from step 2.

Inlet Pressure Switch Testing

▲ WARNING
120 volt potential exposure. Use caution making voltage checks to avoid personal injury.

- Step 1. Position power switch on gas control to the "OFF" position.
- Step 2. Remove the three screws (Phillips screw driver) from control access cover on blower assembly and remove cover (see photo 7).
- Step 3. Remove wires from inlet pressure switch.

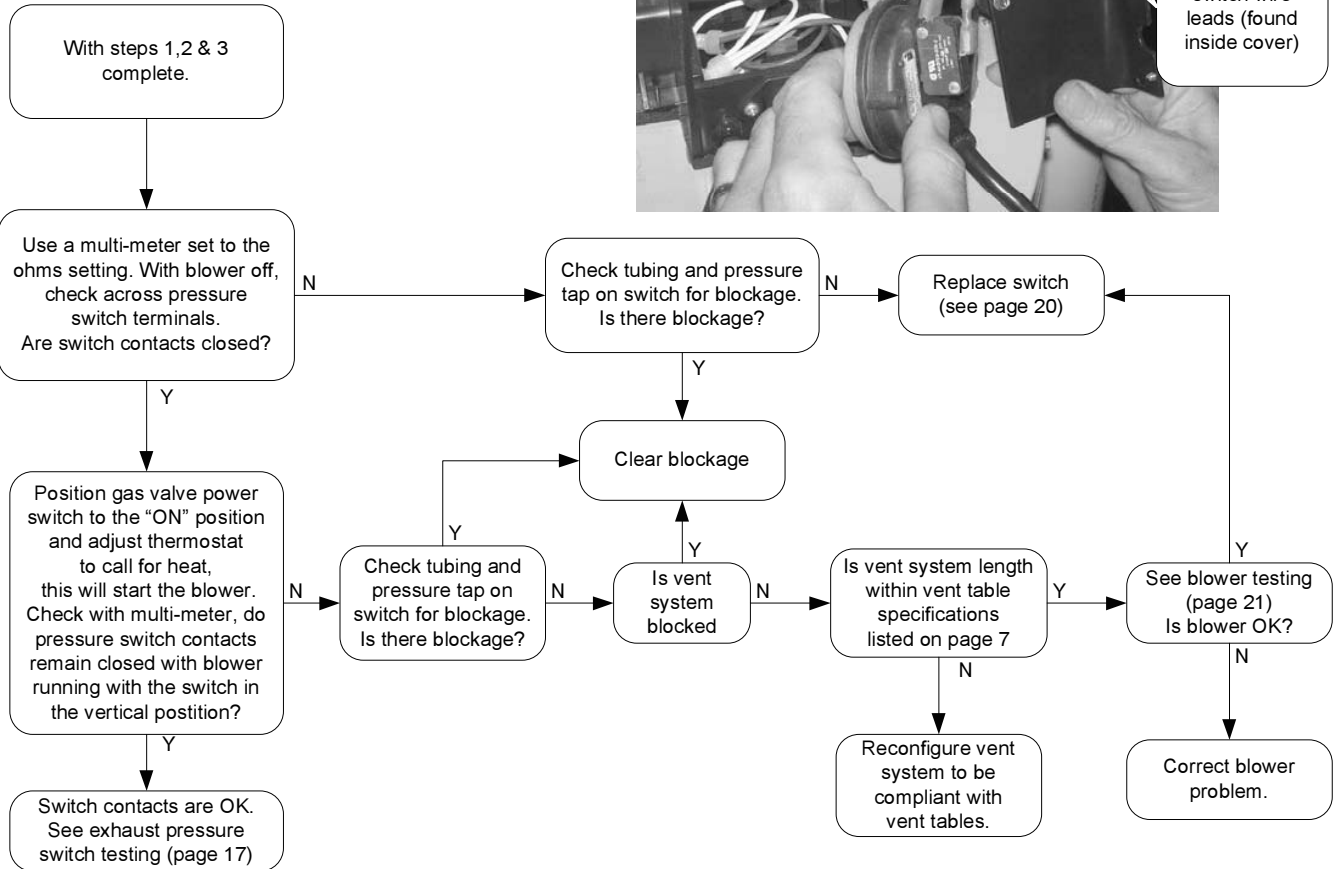
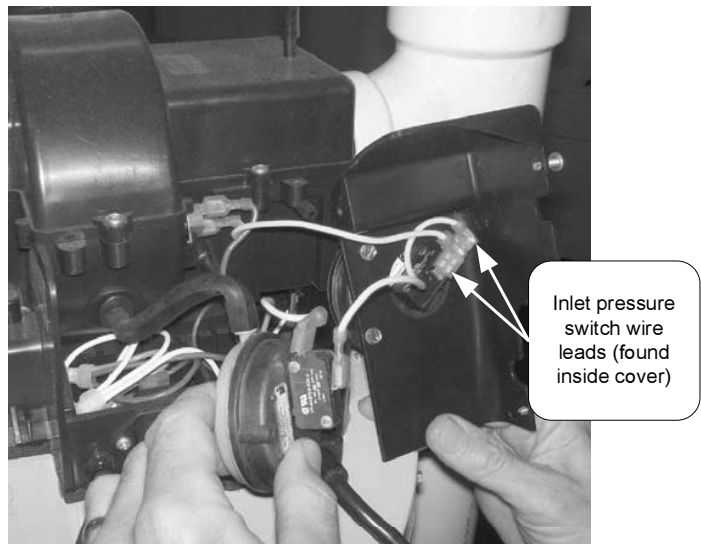
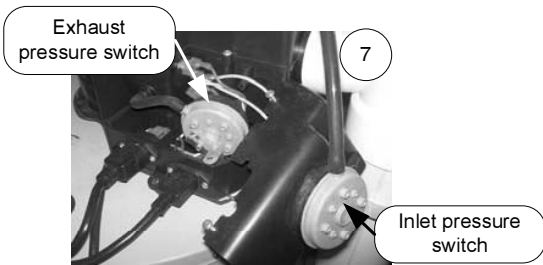

Inlet Pressure Switch Replacement

⚠ WARNING
120 volt potential exposure. Use caution
to avoid personal injury.

- Step 1. Position gas control power switch to “OFF” position.
- Step 2. Remove the three screws (Phillips screw driver) from control access cover on blower assembly and remove cover (see photo 8).
- Step 3. Disconnect the tubing from the pressure switch (see photo 9).

Step 4. Remove inlet pressure switch from blower access cover. (see photo 10).

Step 5. Disconnect yellow wires from pressure switch (see photo 11).

Step 6. Attach new inlet pressure switch to blower control access cover.

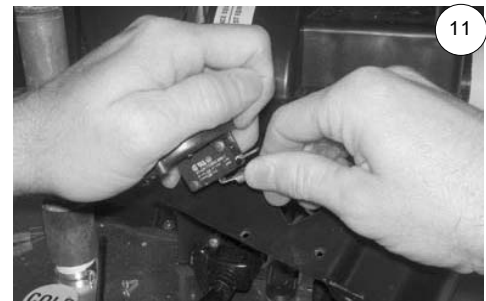
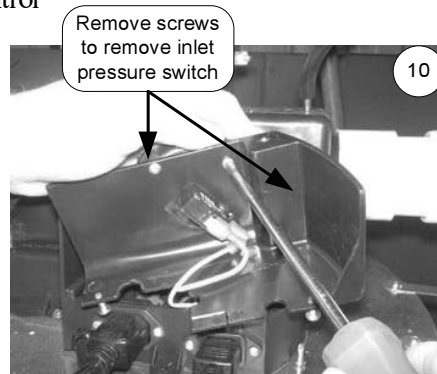
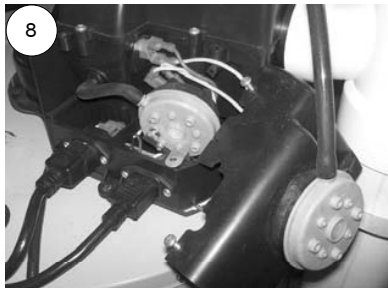

- Step 7. Reconnect wires from step 5 to new pressure switch.
- Step 8. Reconnect tubing to new pressure switch.
- Step 9. Replace control access cover from step 2.
- Step 10. Position gas control power switch to “ON” position and verify proper heater operation.

Blower Testing

⚠ WARNING
115 volt potential exposure. Use caution when making voltage checks to avoid personal injury.

- Step 1. Position gas control power switch to "ON" position and adjust control to call for heat.
- Step 2. Remove the three screws (Phillips Screw driver) from control access cover on blower assembly and remove cover (see photo 12).

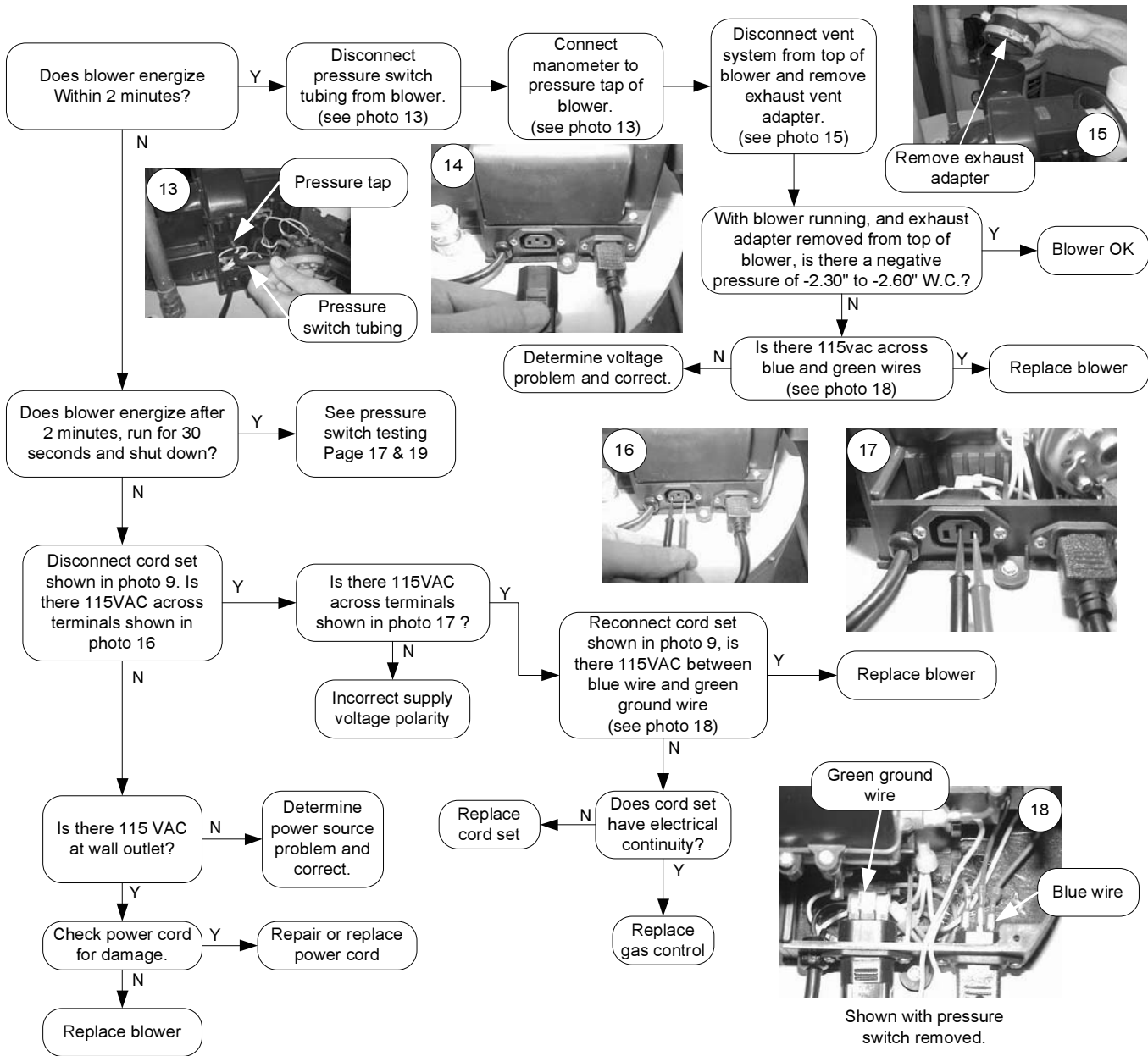
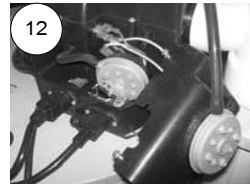

Blower removal

- Step 1. Position gas control power switch to the “OFF” position.
- Step 2. Unplug blower power cord from wall outlet.
- Step 3. Disconnect vent system from exhaust adapter on top of blower.
- Step 4. Remove exhaust adapter from blower (blade screw driver) and retain for use on new blower
- Step 5. Unplug cord sets from blower.
- Step 6. Remove vertical air intake bracket.
- Step 7. Disconnect vertical air intake from blower.
- Step 8. Remove the three blower mounting screws (1/4" nut driver).
- Step 9. Remove blower with gasket from water heater.

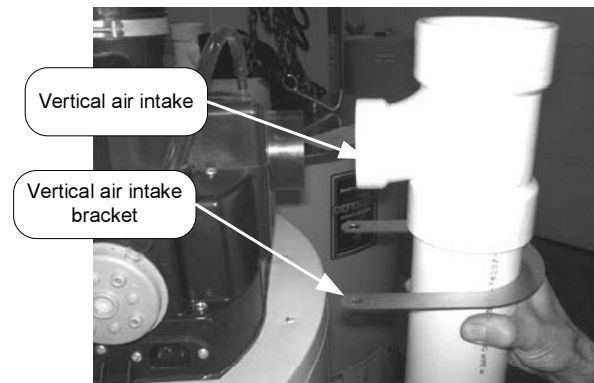
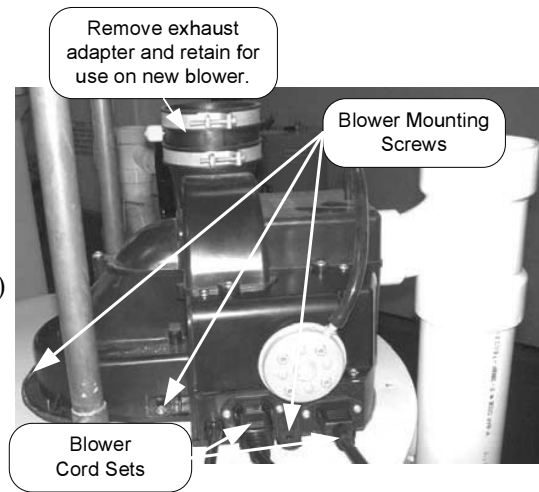

Blower Installation

- Step 10. Clean any debris from jacket head of water heater.
- Step 11. Set new blower with gasket in place using locating pins on blower flange to line up with location holes in jacket head. Be sure not to damage gasket.
- Step 12. Secure blower in place using mounting screws from step 8.
- Step 13. Slide vertical air intake tee onto blower.
- Step 14. Re-install vertical air intake bracket.
- Step 15. Re-install exhaust adapter from step 4.
- Step 16. Reconnect vent system to exhaust adapter.
- Step 17. Reconnect cord sets from step 5.
- Step 18. Plug blower power cord into wall outlet.
- Step 19. Position gas control power switch to the “ON” position.
- Step 20. Verify proper blower operation.

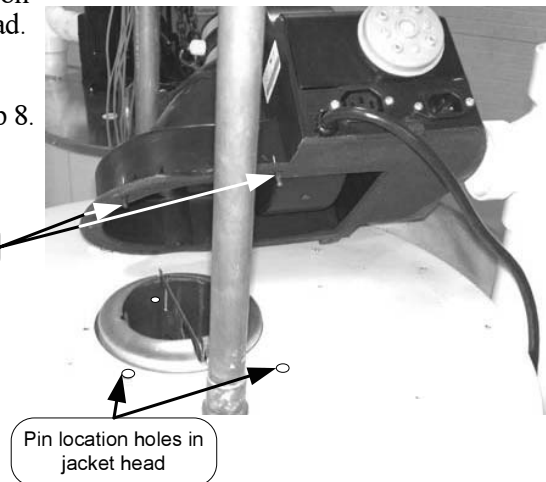

Blower Temperature Switch Testing.

- Step 1. Position power switch on gas control to the "OFF" position.
- Step 2. Remove tubing from inlet pressure tap.
- Step 3. Remove the three screws (Phillips screw driver) from control access cover on blower and remove cover (see photo 19).
- Step 4. Locate blower temperature switch (see photo 19)

⚠ WARNING
120 volt potential exposure. Use caution to avoid personal injury.

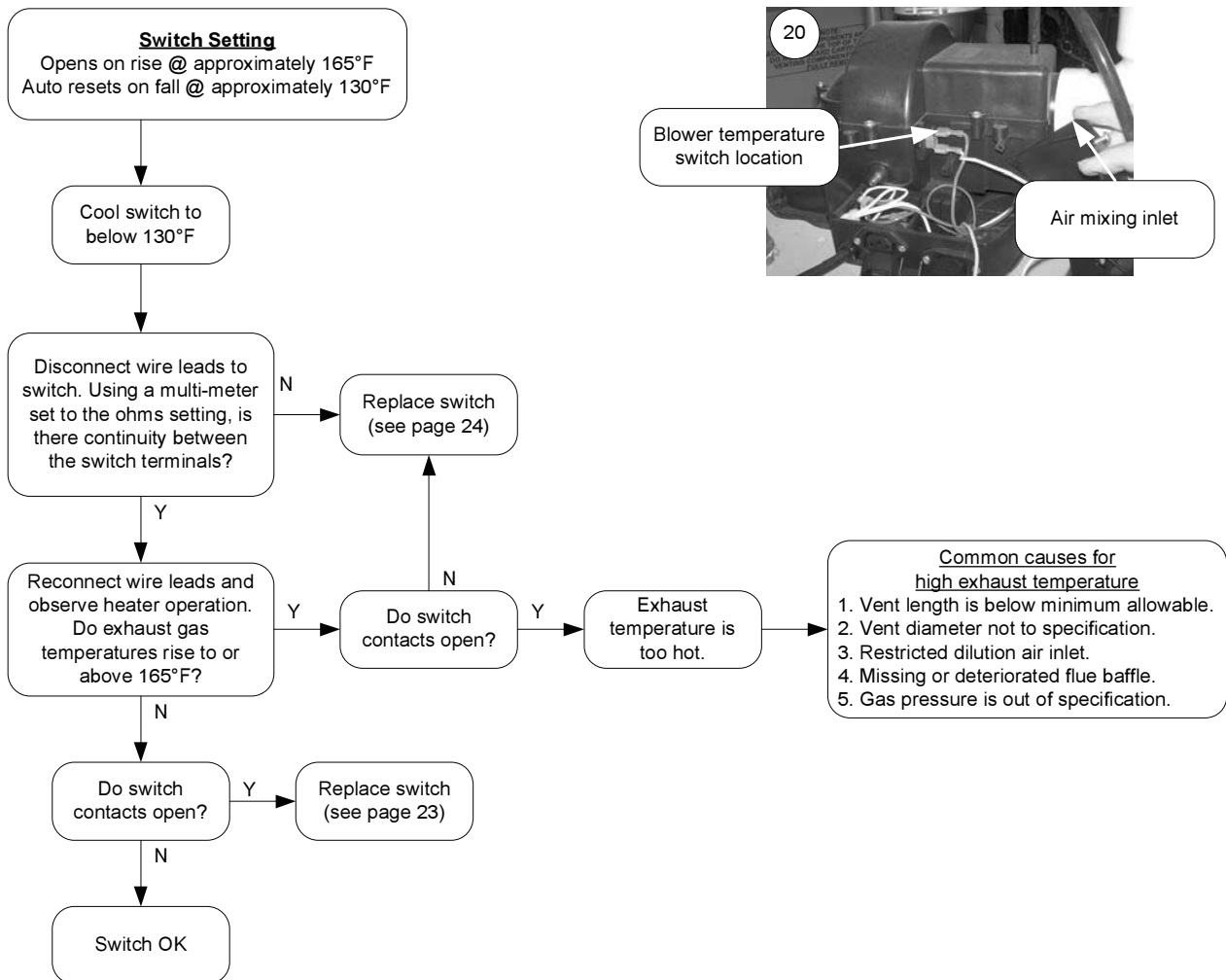
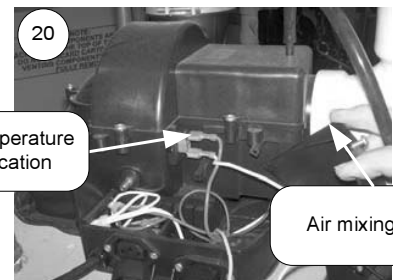
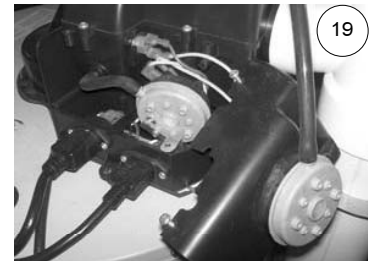

Blower Temperature Switch Replacement.

⚠ WARNING
120 volt potential exposure. Use caution to avoid personal injury.

- Step 1. Position gas control power switch to the “OFF” position and unplug heater from wall outlet.
- Step 2. Remove tubing from inlet pressure tap.
- Step 3. Remove the three screws (Phillips screw driver) from the control access cover on blower and remove cover. (see photo 20)



- Step 4. Locate blower temperature switch (see photo 21)
- Step 5. Disconnect red and yellow wire leads from switch.
- Step 6. With an appropriate tool such as side cutters, snip the retaining lug from the blower housing to allow removal of temperature switch (see photo 22).
- Step 7. Remove switch from blower housing.
- Step 8. Install new switch. Be sure switch is properly seated in mounting area.
- Step 9. Reconnect red and yellows wires to new switch. Wires are interchangeable with either terminal.
- Step 10. Position gas control power switch to the “ON” position and verify proper heater operation.
- Step 11. Replace control access cover from step 2.

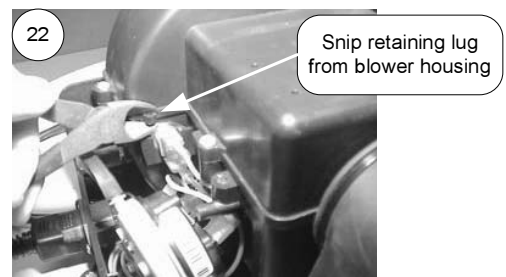
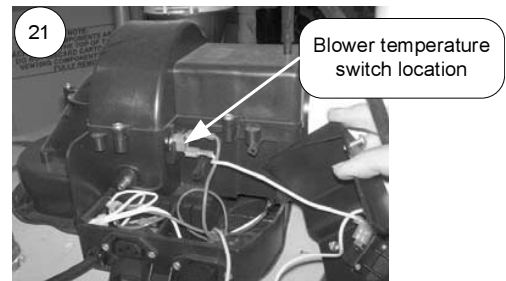

Gas Control Testing

See pages 27 & 28 for gas control input & output testing.

Thermal Well Testing

If Control has gone into TCO lockout due to excessive tank temperature (four flash, 3 second pause) reset control by rotating knob of temperature control to the minimum setting for at least 6 seconds before returning to desired temperature setting.

Observe heater operation. If control continues to lockout due to excessive tank temperature, proceed to thermal well testing to determine cause.

Thermal well testing
Position gas control power switch to the "OFF" position and disconnect thermal well harness from gas control.

Using a multi-meter set to the Ohms setting, determine the resistance of thermal well sensor (see caution photos 23 & 24)

Once the thermal well resistance values are known, the water temperature must also be known to determine if the resistance values are correct. See page 25 to obtain water temperature.

Are thermal well resistance values correct?

N → Replace thermal well (see page 27)

Y → Replace gas control (see page 27)

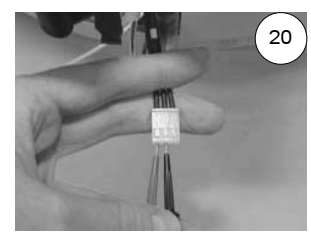
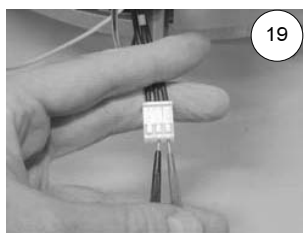

CAUTION
DO NOT use standard multimeter probes for this test. Doing so will damage connector. Use special pin type electronic probes or small diameter wire pins inserted into connector.

Using a multi-meter set to the ohms setting, insert one meter probe (see caution) into center wire position of thermal well connector, insert the second probe (see caution) into either of the outside wire positions (see photo 23).

Alternate the probe on the outside position to the opposite outside wire position (see photo 24).

⚠ WARNING

Stored water may be HOT when performing the following steps in this procedure. Take necessary precaution to prevent personal injury.

Determine Water Temperature Inside Tank

Note: It is important to understand once the resistance for the thermal well is determined from page 25, water flow through the heater should not occur. Prior to performing the steps below, turn off the cold water supply to the water heater. This will prevent cold water flow into the tank affecting the resistance value of thermal well.

- Step 1. Position gas control power switch to “OFF” position.
- Step 2. Draw approximately 4 gallons of water from drain valve into a container and discard. Draw an additional gallon and immediately measure water temperature using an accurate thermometer. It may be necessary to open a hot water faucet to allow heater to drain.
- Step 3. Using the chart below, determine correct resistance value for the water temperature from step 2.

Example: If temperature of water is 84°F, then the resistance through the sensor would be 8449 (see shaded area). NOTE: Sensor resistance increases as the temperature falls.

Sensor Resistance at Various Temperatures

In Degrees F										
°F	0	1	2	3	4	5	6	7	8	9
40	26109	25400	24712	24045	23399	22771	22163	21573	21000	20445
50	19906	19383	18876	18383	17905	17440	16990	16553	16128	15715
60	15314	14925	14548	14180	13823	13477	13140	12812	12494	12185
70	11884	11592	11308	11032	10763	10502	10248	1000	9760	9526
80	9299	9078	8862	8653	8449	8250	8057	7869	7685	7507
90	7333	7165	7000	6839	6683	6531	6383	6238	6098	5961
100	5827	5697	5570	5446	5326	5208	5094	4982	4873	4767
110	4663	4562	4464	4368	4274	4183	4094	4006	3922	3839
120	3758	3679	3602	3527	3453	3382	3312	3244	3177	3112
130	3048	2986	2925	2866	2808	2752	2697	2643	2590	2538
140	2488	2439	2391	2344	2298	2253	2209	2166	2124	2083
150	2043	2004	1966	1928	1891	1856	1820	1786	1753	1720
160	1688	1656	1625	1595	1566	1537	1509	1481	1454	1427
170	1402	1376	1351	1327	1303	1280	1257	1235	1213	1191
180	1170	1150	1129	1110	1090	1071	1953	1035	1017	999
190	982	965	949	933	917	901	886	871	857	842
200	828	814	801	788	775	762	749	737	725	713

Gas Control & Thermal Well Removal From Water Heater

- Step 1. Position gas valve power switch to the "OFF" position and Unplug Heater from power supply.
- Step 2. Drain heater to a point below the gas control level.
- Step 3. Turn off gas supply to water heater and disconnect gas piping from gas control.
- Step 4. Disconnect wire harnesses and burner assembly from gas control.
- Step 5. Remove gas control & thermal well by rotating flats of Thermal Well counter clockwise (1-5/16" wrench).

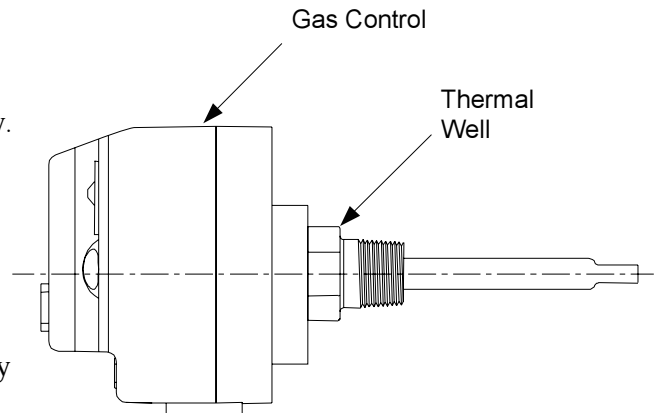

Gas Control Removal From Thermal Well

Follow the steps below allows removal gas control from thermal well without removing thermal well from tank.

- Step 1. Position gas control power switch to the "OFF" position and unplug water heater from power supply.
- Step 2. Turn off gas supply to water heater and disconnect gas piping from gas control.
- Step 3. Disconnect wire harnesses & burner assembly from gas control.
- Step 4. Using gas control service tool (239-45991-00) available from your BWC parts supplier, Insert tool into back of gas control (see photos below)

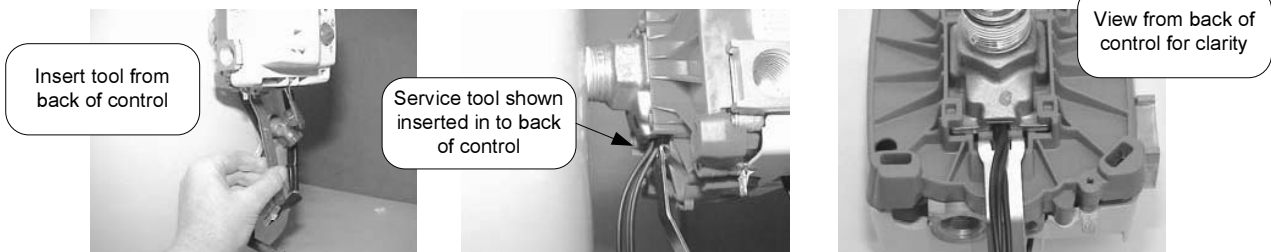

- Step 5. Pivot tool towards heater as far as possible (see photo below). Lift straight up on gas control. The control should move about 1/8". Hold control in position and remove tool. Lift straight up on control to remove completely from Thermal Well.

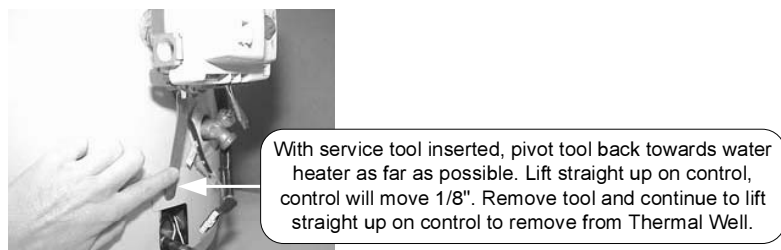

Gas Control Assembly to Thermal Well

- Step 1. Install threaded end of thermal well into tank. Be sure thermal well flange is positioned as shown in photo 24 for proper control alignment.
- Step 2. Route wire leads back into relief opening. (see photo 24)
- Step 3. Align slots located on thermal well flange with tabs located on back of gas control (see photo 24 & 25)
- Step 4. Carefully push control back onto thermal well flange as far as possible towards water heater. Slide control down to lock into position.
- Step 5. Install burner and connect pilot tubing and feedline nut to gas control.

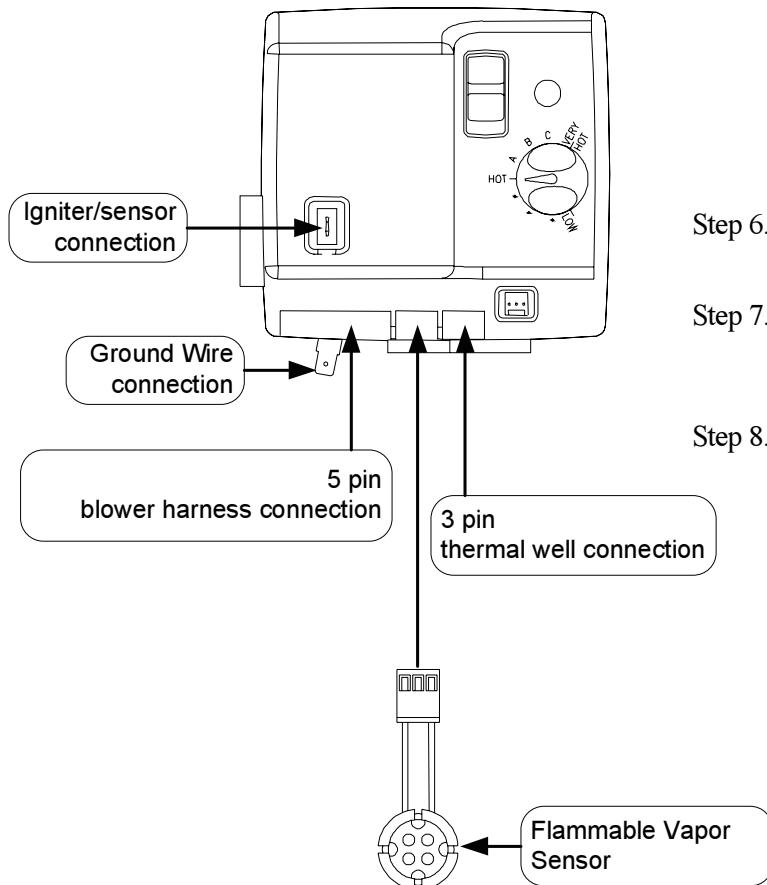
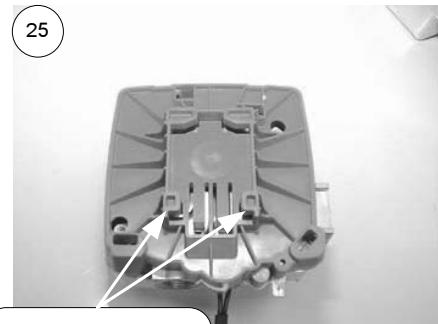
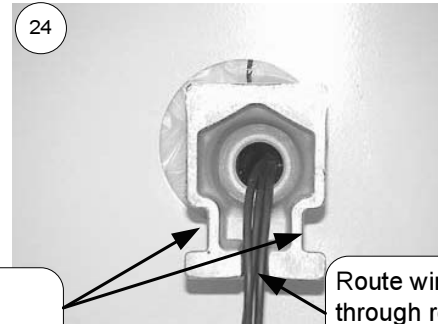

- Step 6. Reconnect wire harnesses to gas control per the illustration.
- Step 7. Reconnect gas piping to gas control. Restore gas supply and check for gas leaks.
- Step 8. To resume operation, follow the instruction located on the lighting instruction label or the lighting instruction located in the installation and operation manual.

Flammable Vapor Device Testing

- Step 1. Position power switch on gas control to the "OFF" position.
- Step 2. Disconnect flammable vapor sensor from gas control.
- Step 3. Using a multi-meter set to the ohms setting check resistance of flammable vapor sensor. (see caution below)
Resistance must be within 3,000 ohms and 48,000 ohms. If outside of this range replace flammable vapor sensor.

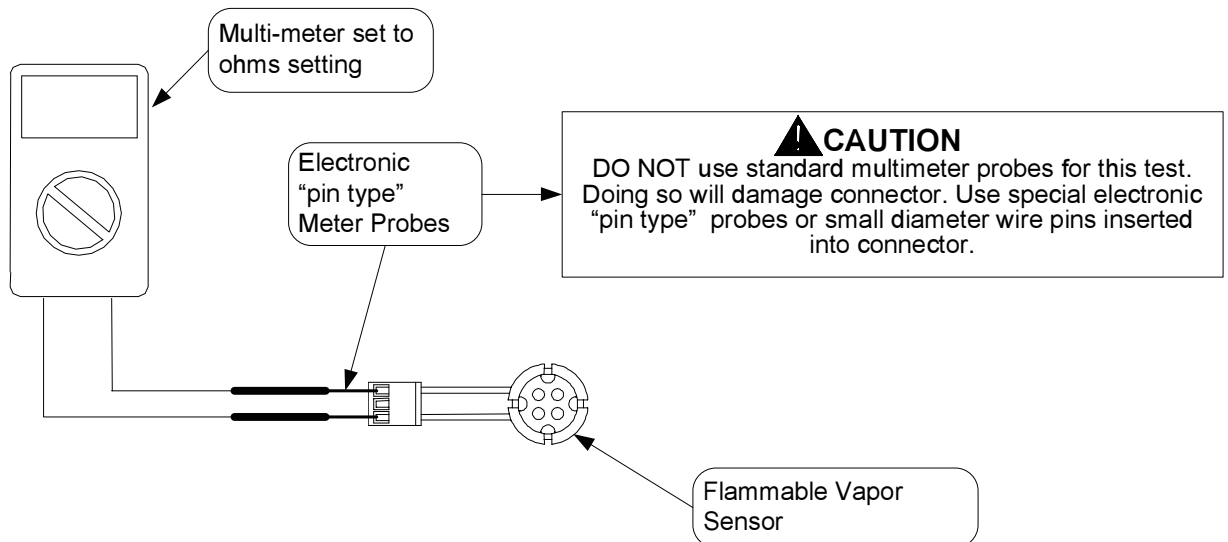
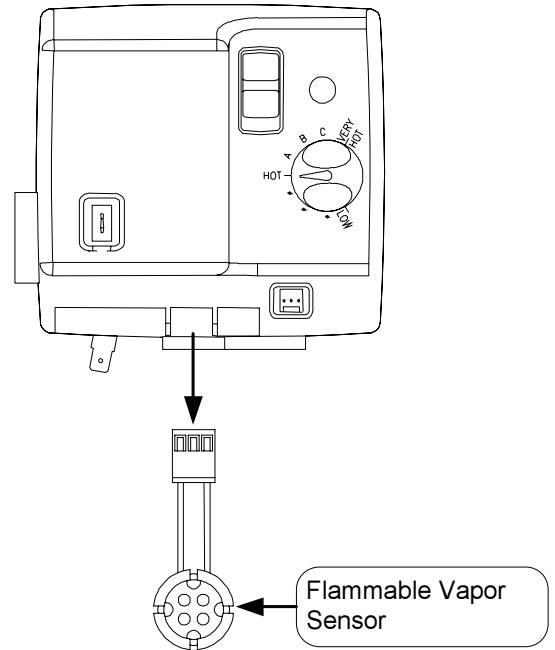

Safety Circuit Voltage Trace

NOTE: This procedure assumes a cool tank.

Step 2. Remove three screws (Phillips Screw driver) from control access cover on blower and remove cover (see photo 26).

▲ WARNING
120 volt potential exposure. Use caution making voltage checks to avoid personal injury.

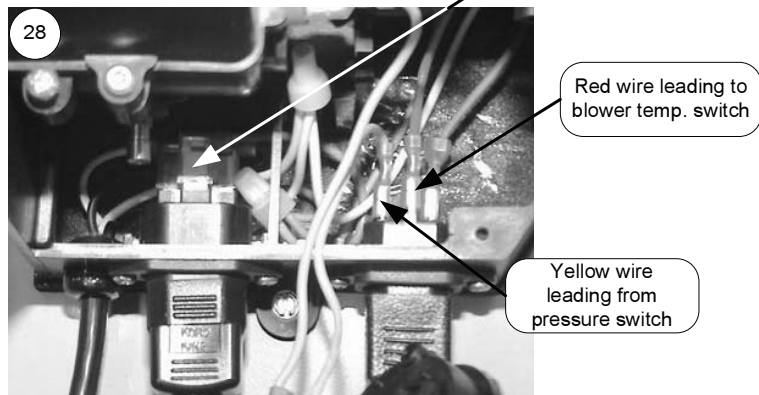
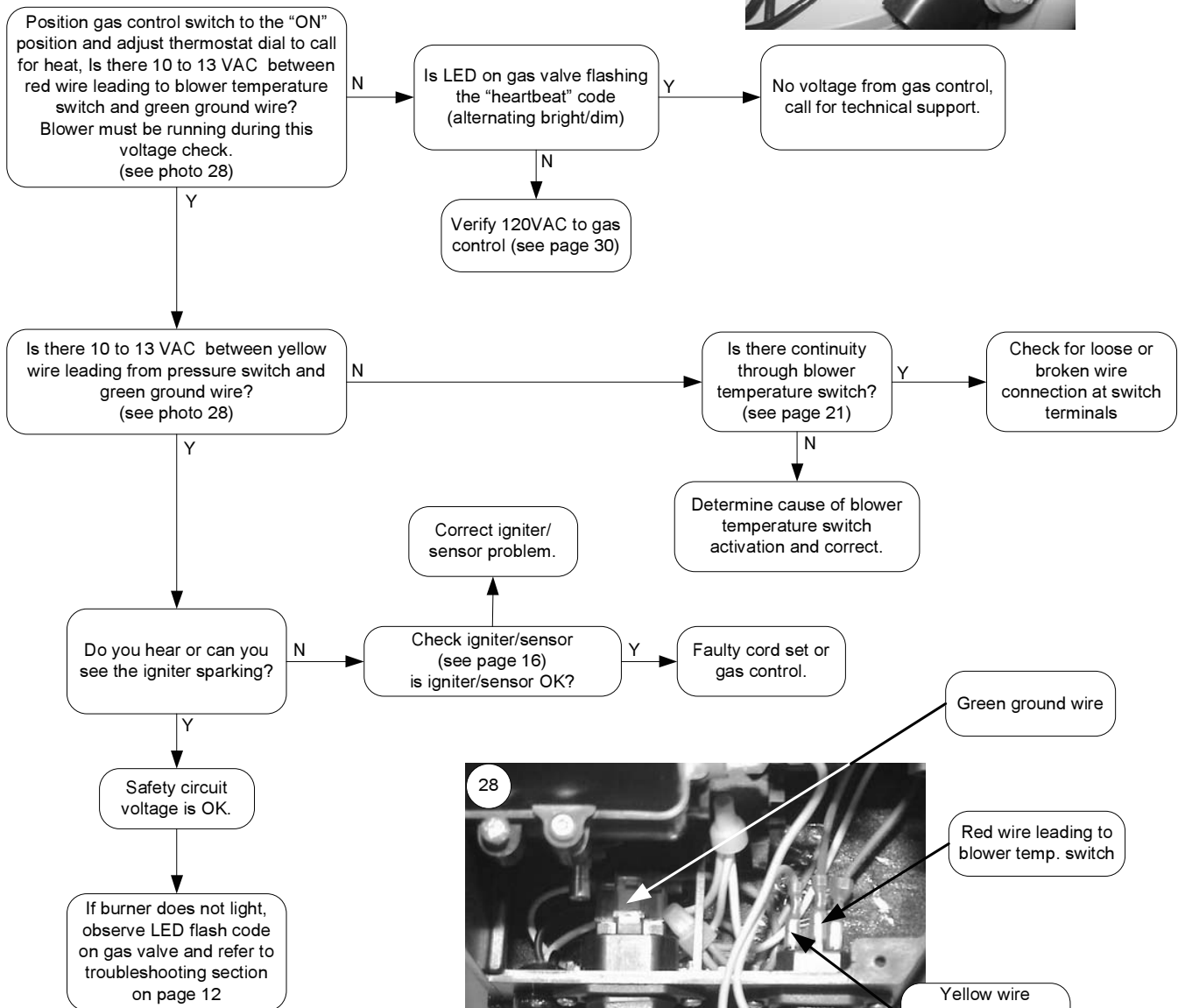

120 VAC Circuit Trace

⚠ WARNING
120 volt potential exposure. Use caution making voltage checks to avoid personal injury.

Step 1. Verify 120VAC and proper polarity at wall outlet.

Step 2. With unit plugged in and control power switch in the "ON" position verify LED status.

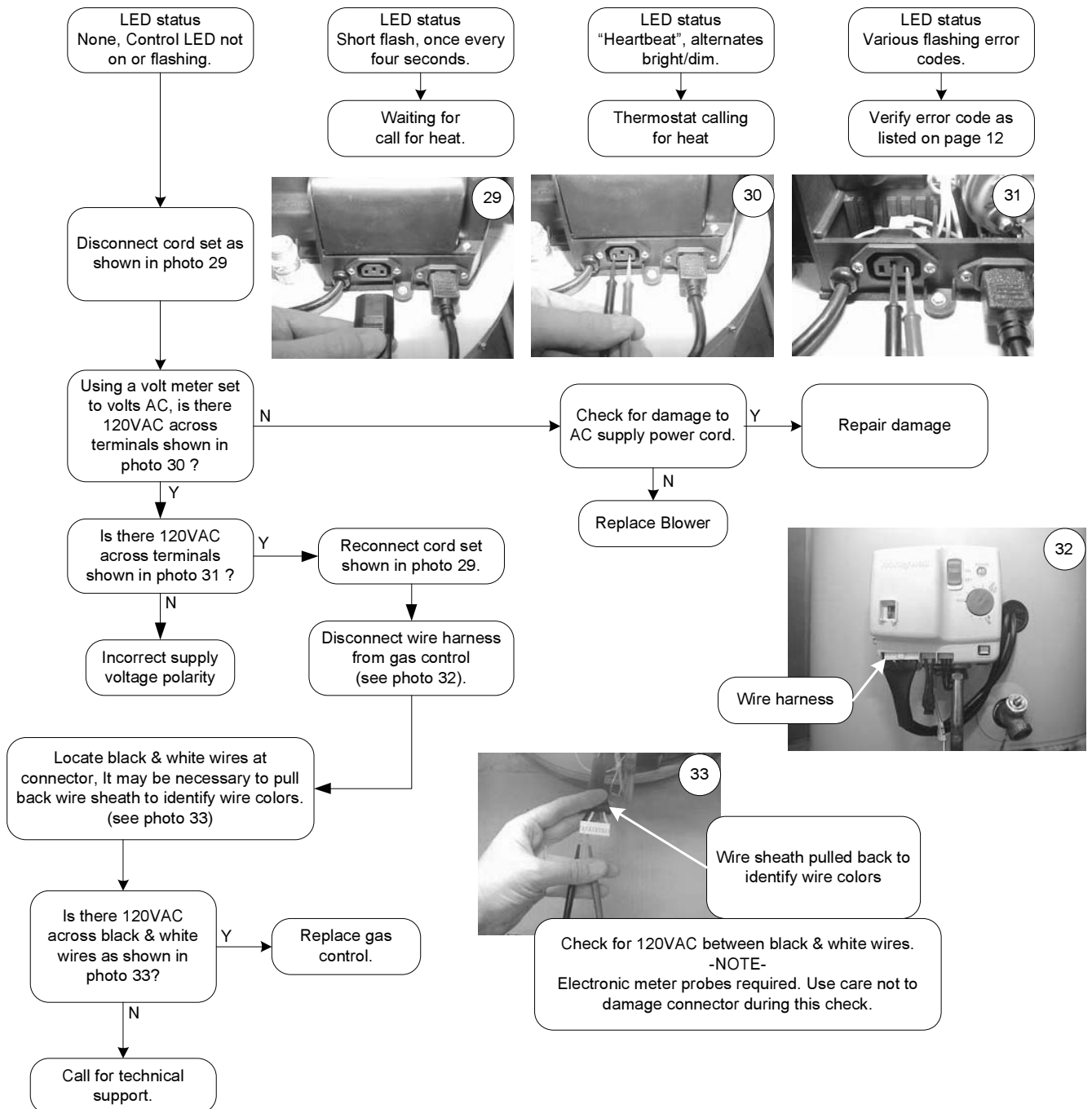

Dip Tube Inspection and Replacement

 **WARNING**

Water Heater components and stored water may be HOT when performing the following steps in this procedure. Take necessary precaution to prevent personal injury.

- Step 1. Position on/off switch of gas control valve to “OFF” position and unplug water heater from wall outlet.
- Step 2. Turn off cold water supply to water heater. Connect hose to drain valve of water heater and route to an open drain. Open a nearby hot water faucet to vent heater for draining. Open drain valve of water heater and allow heater to drain to a point below the inlet connection nipple.
- Step 3. Disconnect inlet nipple from plumbing system.
- Step 4. With an appropriate tool such as a pipe wrench, remove inlet nipple/dip tube from the water heater. Use caution not to damage pipe threads.
- Step 5. Visually inspect inlet nipple/dip tube. Inlet nipple/dip tube should be free of cracks and any blockage. Hydro-jet slots should be open and free of any blockage.

Any damage such as cracks, restriction due to deformation or unintentional holes are not field repairable and the inlet nipple/dip tube must be replaced.
- Step 6. Upon completion of inspection or subsequent replacement, reinstall inlet nipple/dip tube into water heater. Connect nipple to plumbing system, resume water supply and refill with water.
- Step 7. To resume operation follow the instructions located on the lighting instruction label or the lighting instructions located in the installation and operation manual.

Anode Inspection and Replacement

 **WARNING**

Water Heater components and stored water may be HOT when performing the following steps in this procedure. Take necessary precaution to prevent personal injury.

- Step 1. Position on/off switch of gas control valve to the “OFF” position and unplug water heater from wall outlet.
- Step 2. Turn off cold water supply to water heater. Connect hose to drain valve of water heater and route to an open drain. Open a nearby hot water faucet to vent water heater for draining. Open drain valve of water heater and allow water heater to drain to a point below the outlet connection nipple.
- Step 3. Disconnect outlet nipple from plumbing system.
- Step 4. With an appropriate tool such as a pipe wrench, remove outlet nipple/anode from the water heater. Use caution not to damage pipe threads.
- Step 5. Visually inspect outlet nipple/anode. Outlet nipple/anode should show signs of depletion, this is normal. If depletion is $\frac{1}{2}$ of the original anode diameter (approximately $\frac{3}{4}$ ” diameter), replacement is recommended. If any of the steel core of the anode is exposed, replacement is recommended.
- Step 6. Upon completion of inspection or subsequent replacement, reinstall outlet nipple/anode into water heater. Connect nipple to plumbing system, resume water supply and refill with water.
- Step 7. To resume operation, follow the instructions located on the lighting instruction label or the lighting instructions located in the installation and operation manual.

Remove blower to gain access to flue baffle

- Step 1. Position gas control power switch to the "OFF" position and unplug blower from wall outlet.
- Step 2. Disconnect vent system from exhaust adapter on top of blower.
- Step 3. Disconnect intake air piping.
- Step 4. Unplug cord sets from blower. (see photo 34).
- Step 5. Remove the three blower mounting screws (1/4" nut driver) (see photo 34).
- Step 6. Remove blower with gasket from water heater.
- Step 7. Remove flue baffle from Heater (see photo 36).
- Step 8. Inspect baffle for deterioration, missing restrictors. Clean any scale or debris build up. Replace with new baffle as necessary.
- Step 9. Reinstall baffle into flue tube. Be sure baffle hanger tabs are inserted into notch location at the top of the flue tube (see photos 36 & 37).
- Step 10. Check Burner to insure no scale has accumulated during this operation. See burner cleaning procedure on page 15.
- Step 11. Reinstall blower on water heater. Connect vent system and cords set to blower. Plug water heater into wall outlet.
- Step 12. To resume operation follow the lighting instruction located on the lighting instruction label or the lighting instruction located in the installation and operation manual.

Disconnect vent system from exhaust adapter.

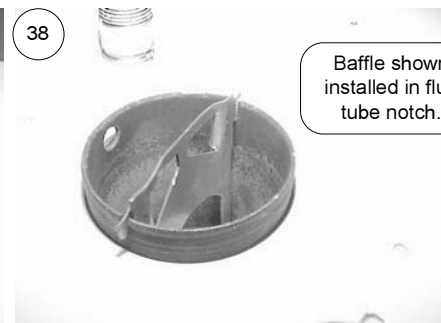
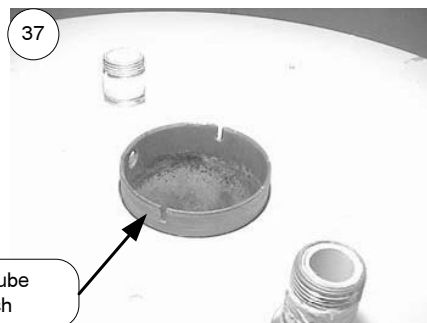
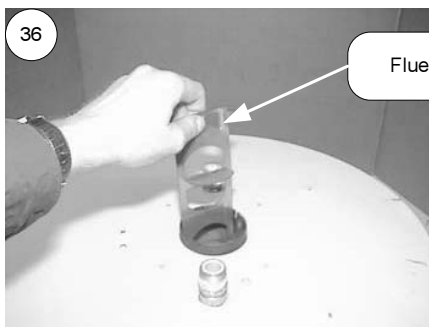
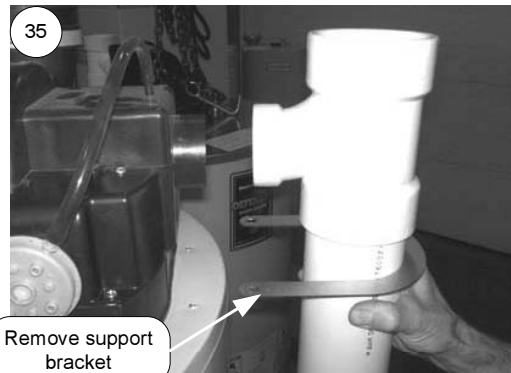
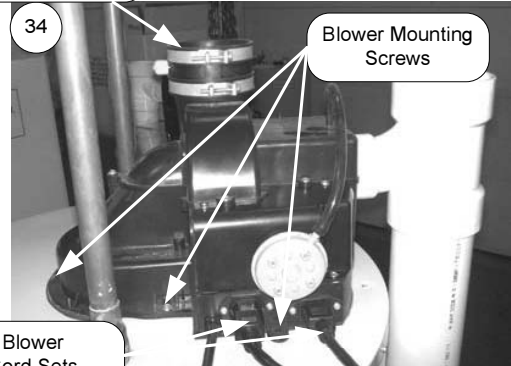

Inner Door Removal Procedure.

Step 1. Slide switch of the Electronic Gas Control to the “OFF” position and unplug from wall.

Step 2. Remove outer jacket burner access door.

Step 3. Disconnect wire connections from Electronic Gas Control.

Step 4. Right side Inner Door Removal.

- a) Remove wire tie from feedline.
- b) Remove (2) 1/4" hex drive screws from right side inner door.
- c) Remove (2) 1/4" hex drive screws from flange section of inner door.
- d) Remove right side inner door and set aside. Be careful not to damage gasket material on inner door.

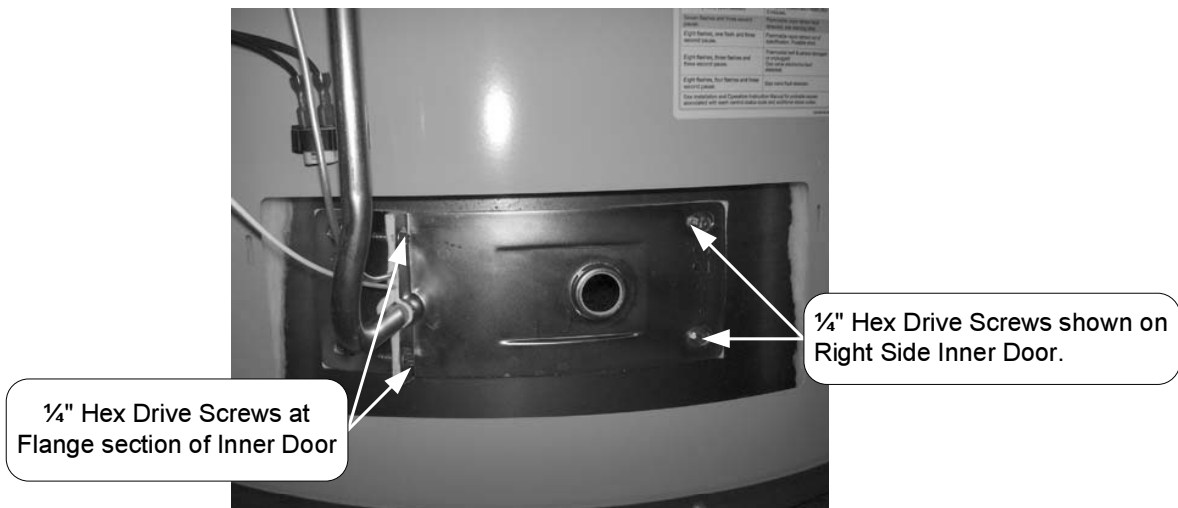

- Step 4. Fully inspect inner door gaskets for the following:
- >Tears
 - >Missing Material
 - >Cracks
 - >Dirt or debris
 - >Other imperfection that will inhibit proper seal
 - >Gasket adhesion to inner door
 - >Material left on combustion chamber (around opening)

If the gasket is not effected by any of the above, gasket replacement is not required. If replacement is required, proceed to Inner Door Gasket Replacement Procedure.

Inner Door Gasket Replacement Procedure.

⚠ WARNING

If the information in these instructions is not followed exactly, a fire or explosion may result causing property damage, personal injury or death.

Step 5. After inspection of inner door as noted in step 4, completely remove gasket and adhesive residue from right and left side inner doors as needed.

Step 6. Use RTV sealant (recommended bead size is 1/8") to secure the inner door gasket to the inner door sections (right & left). Refer to illustration below for proper application. Note the overlap configuration in the flange area of the inner door. Set the flange section first, this will help to achieve the proper overlap position.

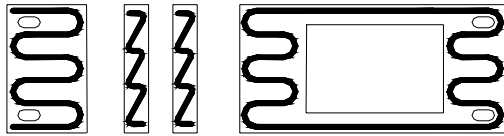

RECOMMENDED PATTERN
FOR RTV SEALANT

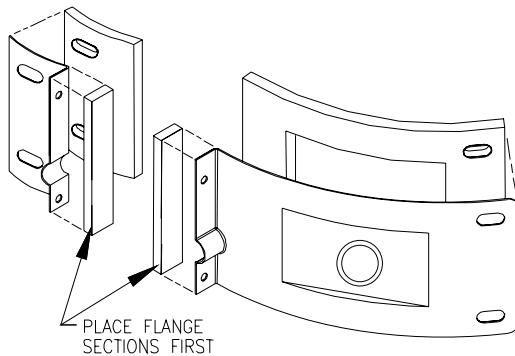

EXPANDED VIEW

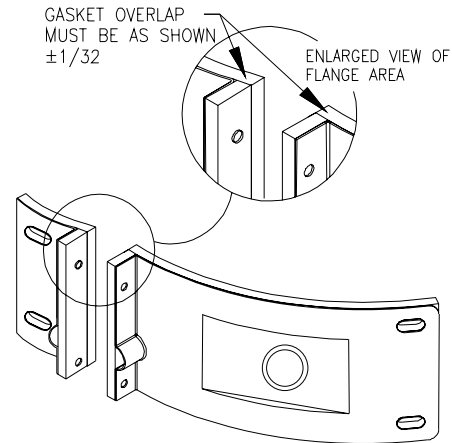

VIEW WITH GASKETS
IN PLACE

Installation of Inner Door With Gasket.

- Step 7. Clean any residual gasket residue or other debris from combustion chamber surface before installing the inner door/gasket assembly.
- Step 8. Place the left side inner door into position first. Firmly position the radiused channel of the inner door around the feedline. Using the 1/4" hex drive screws from step 3d, secure left side inner door in place. **DO NOT OVER TIGHTEN SCREWS.**
- Step 9. Position thermocouple, pilot tube and Piezo wire against left side inner door flange gasket. **DO NOT ROUTE THROUGH RADIUSED CHANNEL WITH FEEDLINE.**

▲ WARNING
Stripped fastener connections may allow for seal breach of inner door. A seal breach may result in a fire or explosion causing property damage, personal injury or death. Do not over tighten screws in steps 8, 10 and 11.

If a fastener connection is stripped, contact the manufacturer listed on the water heater rating plate.

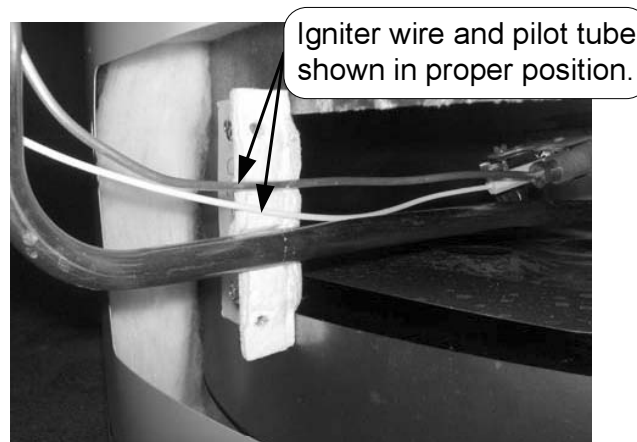

Installation of inner door with gasket (continued from page 36).

- Step 10. Firmly place right side inner door flange against the left side inner door flange and secure with two 1/4" drive screws from step 3c. **DO NOT OVER TIGHTEN SCREWS.**
- Step 11. Align right side inner door to combustion chamber and verify the fastener holes of the combustion chamber are aligned with the right side inner door slotted opening. Verify seal integrity around combustion opening. Secure right side inner door using 1/4" hex drive screws from step 3b. **DO NOT OVER TIGHTEN SCREWS.** Verify both left and right sides of the inner door are properly positioned and sealed against the combustion chamber

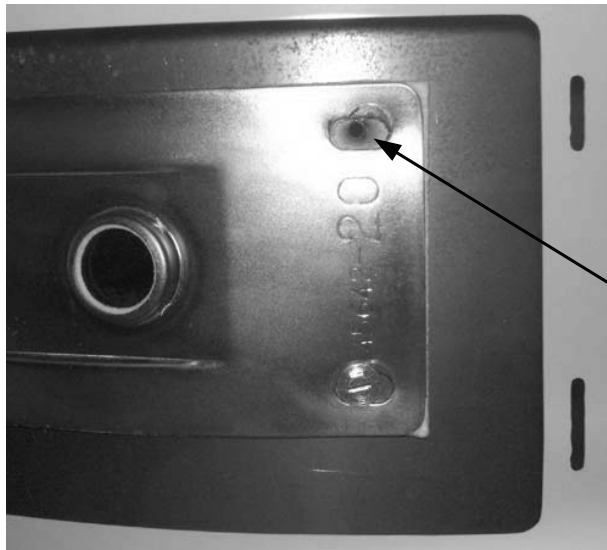

Verify threaded hole alignment with slotted openings in inner door.

- Step 12. Replace outer jacket burner access door.
- Step 13. To resume operation follow the instructions located on the lighting instruction label or the lighting instructions located in the installation and operation manual.

PDX Series

Parts List

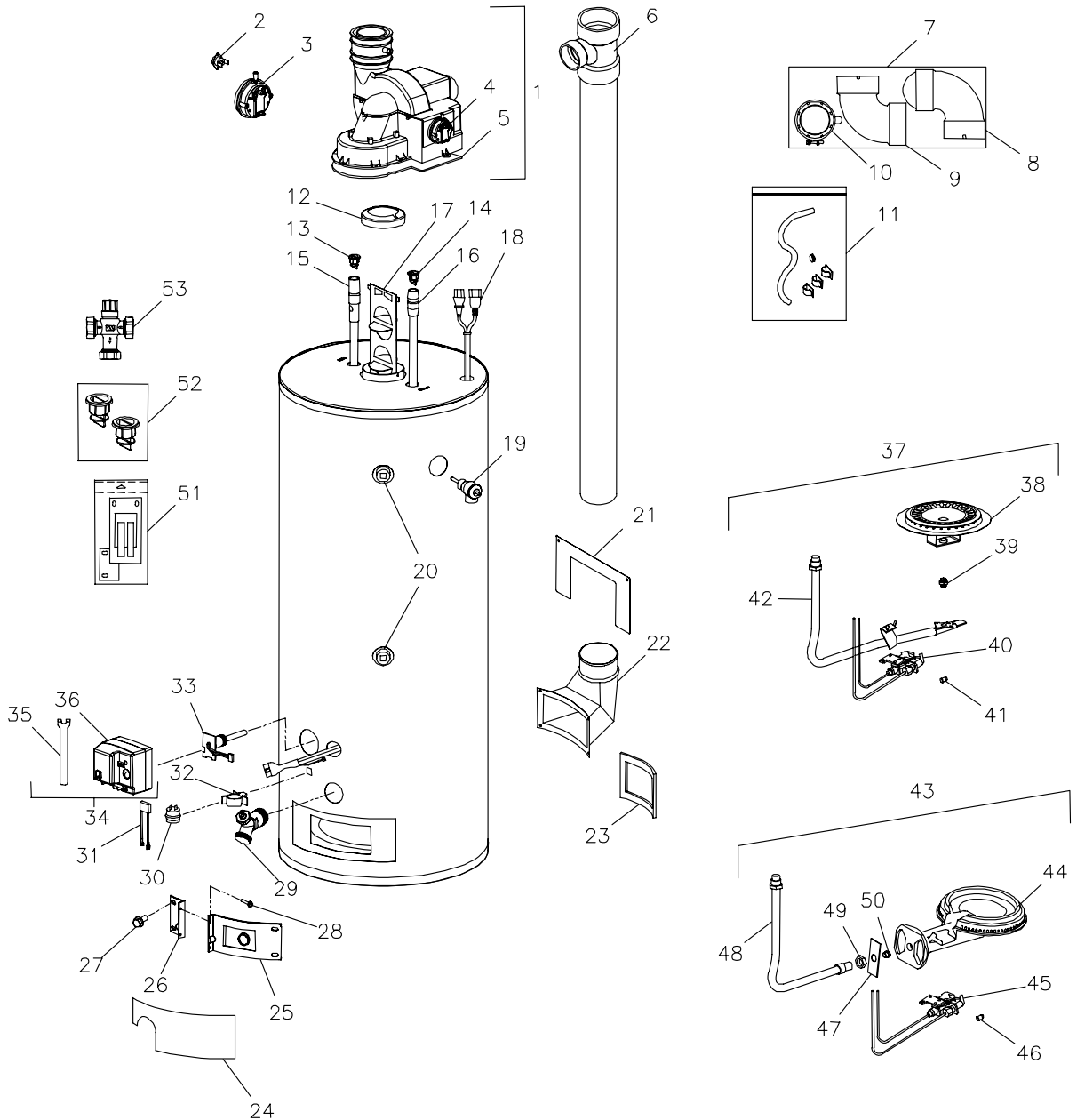

- | | | | |
|-------------------------------|------------------------------|---------------------------------|--------------------------------|
| 1. Blower Assembly | 15. Hot Water Outlet Anode | 28. Screw-#8-18 x 3/4 HWH | 41. Gas Pilot Orifice (Nat.) |
| 2. Blower Temp. Switch | 16. Cold Water Inlet Diptube | 29. Brass Drain Valve | 42. Gas Feedline (Nat.) |
| 3. Exhaust Pressure Switch | 17. Flue Baffle | 30. Flammable Vapor Sensor | 43. Gas Burner Assy (L.P.) |
| 4. Inlet Pressure Switch | 18. Blower Harness | 31. Sensor Harness | 44. Cast Iron Burner (L.P.) |
| 5. Blower Gasket | 19. T&P Relief Valve | 32. Flammable Vapor Sensor Clip | 45. Gas Pilot Assy (L.P.) |
| 6. Tee and Vent Pipe Assy. | 20. 3/4 NPT PLUG | 33. Thermal Well | 46. Gas Pilot Orifice (L.P.) |
| 7. Vent Adapter with Term. | 21. Direct Vent Boot | 34. Gas Control Kit | 47. Air Shutter (L.P.) |
| 8. Intake Terminal | 22. Air Intake Boot | 35. Gas Control Service tool | 48. LP Gas Feedline (L.P.) |
| 9. Vent Terminal Elbow | 23. Air Intake Boot Gasket | 36. Gas Control | 49. Air Shutter Nut (L.P.) |
| 10. Exhaust Adapter | 24. Outer Door | 37. Gas Burner Assy (Nat.) | 50. Main Burner Orifice (L.P.) |
| 11. Condensate Hose Kit | 25. Right Side Inner Door | 38. Gas BN burner (Nat.) | 51. Inner Door Gasket |
| 12. Flue Reducer | 26. Left Side Inner Door | 39. Main Burner Orifice (Nat.) | 52. Heat Trap Insert kit |
| 13. Heat Trap Insert (outlet) | 27. Screw-#10-12 x 3/4 HWH | 40. Gas Pilot Assembly (Nat.) | 53. Mixing Valve |
| 14. Heat Trap Insert (inlet) | | | |



Ambler, PA

For U.S. and Canada field service,
contact your professional installer or
local Bradford White sales representative.

Sales/800-523-2931
Fax/215-641-1670

Technical Support/800-334-3393
Fax/269-795-1089

Warranty/800-531-2111
Fax/269-795-1089

International:
Telephone/215-641-9400
Telefax/215-641-9750



Sales/866-690-0961
905-238-0100

Fax/905-238-0105

Technical Support/800-334-3393

Email

parts@bradfordwhite.com
techserv@bradfordwhite.com

www.bradfordwhite.com